

EPSOLAR

Utility model patent NO.

201120064092.1

Tracer-2210RN / 2215RN

— **Maximum Power Point Tracking Solar Charge Controller**

INSTRUCTION MANUAL

Thank you very much for selecting our product!

This manual offers important information and suggestions with respect to installation, use and troubleshooting, etc. Please read this manual carefully before using the product and pay attention to the safety recommendations in it.

Tracer-2210RN / 2215RN

— Maximum Power Point Tracking Solar Charge Controller



Specification Summary

System Voltage	12 / 24VDC
Rated Battery Current	20A
Rated Load Current	20A
Max. PV Input Voltage**	
Tracer-2210RN	100VDC
Tracer-2215RN	150VDC
Max. PV Input Power	
12V System	260W
24V System	520W

***Array voltage should never exceed maximum PV input voltage. Refer to the solar module documentation to determine the highest expected array Voc (open circuit voltage) as defined by the lowest expected ambient temperature for the system location.*

Contents

1 Important Safety Information	1
2 General Information	2
2.1 Overview.....	2
2.2 Optional Accessories.....	4
3 Installation Instructions	4
3.1 General Installation Notes.....	4
3.2 Mounting.....	4
3.3 Wiring	5
4 Operation.....	10
4.1 MPPT Technology	10
4.2 Battery Charging Information	11
4.3 LED Indications	13
4.4 Setting Operation	14
5 Protections, Troubleshooting and Maintenance	20
5.1 Protection	20
5.2 Troubleshooting	20
5.3 Maintenance.....	22
6 Warranty	23
7 Technical Specifications	24

1 Important Safety Information

Save These Instructions

This manual contains important safety, installation and operating instructions for Tracer

The following symbols are used throughout this manual to indicate potentially dangerous conditions or mark important safety instructions, please take care when meeting these symbols



WARNING: Indicates a potentially dangerous condition.

Use extreme caution when performing this task.



CAUTION: Indicates a critical procedure for safe and proper

operation of the controller



NOTE: Indicates a procedure or function that is important for the

safe and proper operation of the controller.

General Safety Information

Read all of the instructions and cautions in the manual before beginning installation

There are no user serviceable parts inside the Tracer Do not disassemble or attempt to repair the controller

Disconnect the solar module and fuse/breakers near to battery before installing or adjusting the Tracer

Install external fuses/breakers as required

Do not allow water to enter the controller

Confirm that power connections are tightened to avoid excessive heating from loose connection

2 General Information

2.1 Overview

Thank you for selecting the Tracer controller which represents advanced technology of our company. The features are listed below:

12V / 24V auto recognition

Advanced maximum power point tracking technology to optimize using the solar system

Peak conversion efficiency of 97 %, high Tracking efficiency of 99%

Very fast sweeping of the entire I-V curve, several seconds tracking speed

Widely used, automatic recognize day/night

Timer function with 1-15 hours option for street light

Unique dual timer function, enhance the flexibility of street light system

Sealed, Gel and Flooded battery option

Adopting temperature compensation and correcting the charging and discharging parameters automatically, improving the battery lifetime

Electronic protection: over charging, over discharging, overload, short circuit

Reverse protection: any combination of solar module and battery, without causing damage to any component

Excellent thermal design and nature air cooling

RJ45 interface with remote meter MT-5, convenient to check operating parameters of controllers

The Tracer series controller is for off-grid solar system and control the charging and discharging of the battery, especially suitable for the street light system. The controller features a smart tracking algorithm inside that maximizes the energy from the solar PV module(s) and charge the battery. At the same time, the low voltage disconnect function (LVD) will prevent the battery from over discharging.

The Tracer controller charging process has been optimized for long battery life and improved system performance. The comprehensive self-diagnostics and electronic protection functions can prevent damage from installation mistakes or system faults. In addition, the Tracer controller has a RJ45 interface to allow communication with a meter for remote monitoring.

Although the Tracer controller is very simple to configure and use, please take your time to read the operator's manual and become familiar with the controller. This will help you make full use of all the functions and improve your solar PV system.

The features of Tracer controller:

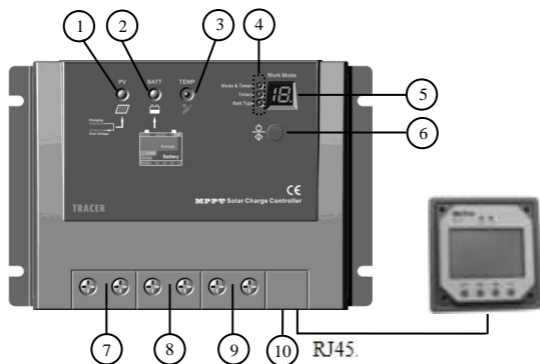

Figure 2-1 Tracer Characteristics

1 – Charging Status LED Indicator

An LED indicator that shows charging status and overvoltage of battery

2 – Battery Status LED Indicator

An LED indicator that shows battery status or system errors

3 – Temperature Sensor

Measure ambient temperature and make temperature compensation for charging and discharging

4 – Setting Indicators

Corresponding indicator will be on when set timer1, timer2 and battery type

5 – LED Digital Display

Display the load work mode and status

6 – Setting Button (in manual mode used for load ON/OFF)

Set load work mode and select battery type

7 – Solar Module Terminals

Connect solar modules

8 – Battery Terminals

Connect batteries

9 – Load Terminals

Connect loads

10 – RJ45 Communication Interface

Communicate with remote meter MT-5

2.2 Optional Accessories

Remote Meter(Model: MT-5)

The digital remote meter displays system operating information, error indications, and self-diagnostics read-out. Information is displayed on a backlit LCD display. The large numerical display and icons are easy to read and large buttons make navigating the meter menus easy. The meter can be flush mounted in a wall or surface mounted using the mounting frame (included). The MT-5 is supplied with 2m of cable and a mounting frame. The MT-5 connects to the RJ45 port on the Tracer.

3 Installation Instructions

3.1 General Installation Notes

- Read through the entire installation section first before beginning installation.
- Be very careful when working with batteries. Wear eye protection. Have fresh water available to wash and clean any contact with battery acid.
- Use insulated tools and avoid placing metal objects near the batteries.
- Explosive battery gasses may be present during charging. Be certain there is sufficient ventilation to release the gasses.
- Avoid direct sunlight and do not install in locations where water can enter the controller.
- Loose power connections and/or corroded wires may result in resistive connections that melt wire insulation, burn surrounding materials, or even cause fire. Ensure tight connections and use cable clamps to secure cables and prevent them from swaying in mobile applications.
- Use with Gel, Sealed or Flooded batteries only.
- Battery connection may be wired to one battery or a bank of batteries. The following instructions refer to a singular battery, but it is implied that the battery connection can be made to either one battery or a group of batteries in a battery bank.
- Select the system cables according to $3A/mm^2$ current density.

3.2 Mounting



NOTE: When mounting the Tracer, ensure free air through the controller heat sink fins. There should be at least 150mm of clearance above and below the controller to allow for cooling. If mounted in an enclosure, ventilation is highly recommended.



WARNING: Risk of explosion! Never install the Tracer in a sealed enclosure with flooded batteries! Do not install in a confined area where battery gas can accumulate.

Step 1: Choose Mounting Location

Locate the Tracer on a vertical surface protected from direct sun, high temperature, and water

Step 2: Check for Clearance

Place the Tracer in the location where it will be mounted. Verify that there is sufficient room to run wires and that there is sufficient room above and below the controller for air flow

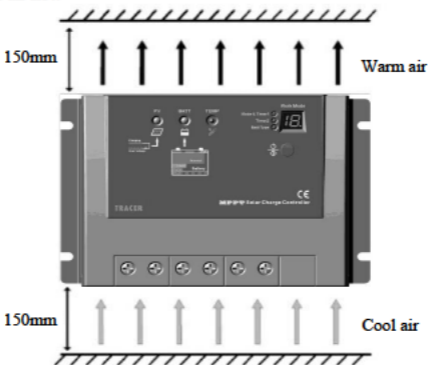

Figure 3-1 Mounting and cooling

Step 3: Mark Holes

Use a pencil or pen to mark the four (4) mounting hole locations on the mounting surface

Step 4: Drill Holes

Remove the controller and drill four sizeable holes in the marked locations

Step 5: Secure Controller

Place the controller on the surface and align the mounting holes with the drilled holes in step 4. Secure the controller in place using the mounting screws

3.3 Wiring



NOTE: A recommended connection order has been provided for maximum safety during installation.



NOTE: The Tracer is a negative ground controller. Any negative connection of solar module, battery or load can be earth grounded as required. Grounding is recommended.



CAUTION: Don't connect the loads with surge power exceeding the ratings of the controller.



CAUTION: For mobile applications, be sure to secure all wiring. Use cable clamps to prevent cables from swaying when the vehicle is in motion. Unsecured cables create loose and resistive connections which may lead to excessive heating and/or fire.

Step 1: Battery Wiring



WARNING: Risk of explosion or fire! Never short circuit battery positive (+) and negative (-) or cables

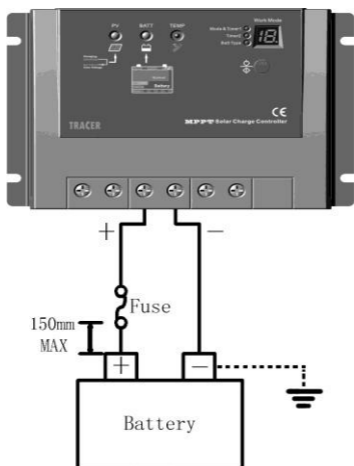

Figure 3-2 Battery wiring

Before connecting the battery, measure the battery voltage. It must be over 9V to power the controller. For 24V, the voltage must be greater than 18V to properly detect a 24V battery. The 12/24V battery detection is automatic and the check is only performed at start-up.

Wire an in-line fuse holder no more than 150mm from the battery positive terminal. Do not insert a fuse at this time. Confirm the connection correct and then turn on the power.

Step 2: Load Wiring

The Tracer load output can connect DC electronic devices of which rated voltage is same as battery's. Tracer will provide battery voltage to the loads. See Section 4.4 Setting Operation for more details about the load control.

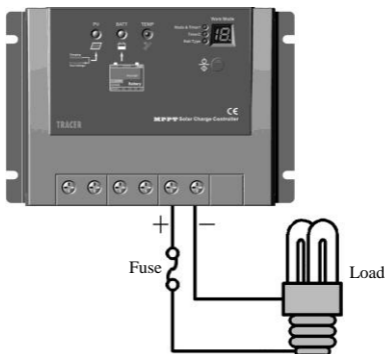

Figure 3-3 Load wiring

Connect load positive (+) and negative (-) to the Tracer load output as shown in figure 3-3. The load terminals may exist voltage, connect carefully to avoid short circuit.

An in-line fuse holder should be wired in series in the load positive (+) or negative (-) wire as shown. Do not insert a fuse at this time. Confirm the connection correct and then turn on the power.

If wiring the load connection to a load distribution panel, each load circuit should be fused separately. The total load draw should not exceed the 20A load rating.

Step 3: Solar Module Wiring



WARNING: Risk of electric shock! Exercise caution when handling solar wiring. The solar module(s) high voltage output can cause severe shock or injury. Cover the solar module(s) from the sun before installing solar wiring.

The Tracer can accept 12V, 24V nominal off-grid solar module arrays. Grid-tie solar module(s) may be used if the open circuit voltage does not exceed the maximum solar input rating. The solar module(s) nominal voltage must be equal to or greater than the nominal battery voltage.

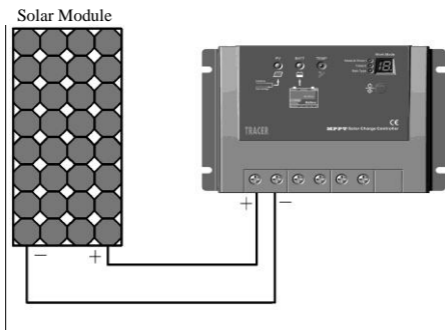

Figure3-4 Solar Module wiring

Step 4: Accessories (option)

Install Remote Meter (purchased separately) if required Refer to the instructions provided for detailed installation procedures

Step 5: Confirm Wiring

Double-check the wiring in step1 through 4 Confirm correct polarity at each connection Verify that all six power terminals are tightened

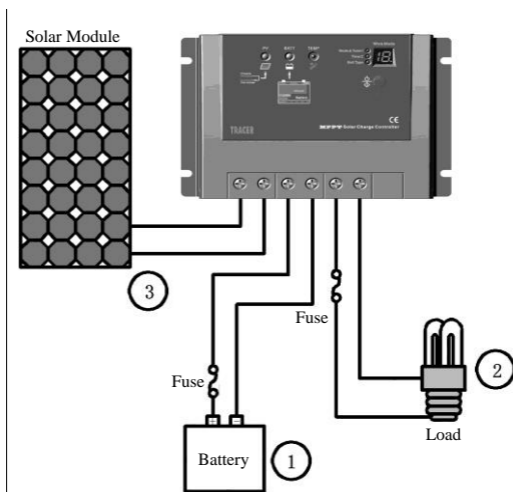

Figure3-5 System Wiring review

Step 6: Confirm Power-up

When battery power is applied and the Tracer powers up, the battery led indicator will be green

If the Tracer does not power up or battery status LEDs error exists, refer to Section 5 Troubleshooting

4 Operation

4.1 MPPT Technology

The Tracer utilizes Maximum Power Point Tracking technology to extract maximum power from the solar module (s) The tracking algorithm is fully automatic and does not require user adjustment, Tracer technology will track the array *maximum power point voltage* (V_{mp}) as it varies with weather conditions, ensuring that maximum power is harvested from the array through the course of the day

Current Boost

In many cases, Tracer MPPT technology will “boost” the solar charge current For example, a system may have 8 Amps of solar current flowing into the Tracer and 10 Amps of charge current flowing out to the battery The Tracer does not create current! Rest assured that the power into the Tracer is the same as the power out of the Tracer Since power is the product of voltage and current (Volts \times Amps), the following is true*:

- (1) Power Into the Tracer = Power Out of the Tracer
- (2) Volts In \times Amps In = Volts Out \times Amps Out

* Assuming 100% efficiency Actually, the losses in wiring and conversion exist

If the solar module's V_{mp} is greater than the battery voltage, it follows that the battery current must be proportionally greater than the solar input current so that input and output power are balanced The greater the difference between the maximum power voltage and battery voltage, the greater the current boost Current boost can be substantial in systems where the solar array is of a higher nominal voltage than the battery

An Advantage Over Traditional Controllers

Traditional controllers connect the solar module directly to the battery when recharging This requires that the solar module operate in a voltage range that is below the module's V_{mp} In a 12V system for example, the battery voltage may range from 11-15Vdc but the module's V_{mp} is typically around 16 or 17V

Figure 4-1 shows a typical current VS voltage output curve for a nominal 12V off-grid module

Current VS Voltage in 12V system

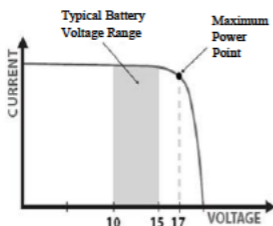

Output power in 12V system

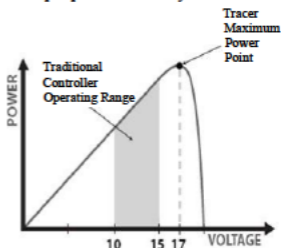

Figure 4-1 Nominal 12V Solar Module I-V curve and output power graph

The array V_{mp} is the voltage where the product of current and voltage (Amps×Volts) is greatest, which falls on the “knee” of the solar module I-V curve as shown in Figure4-1. Because Traditional controllers do not operate at the V_{mp} of the solar module(s), energy is wasted that could otherwise be used to charge the battery and power system loads. The greater the difference between battery voltage and the V_{mp} of the module, the more energy is wasted.

Tracer MPPT technology will always operate at the V_{mp} resulting in less wasted energy compared to traditional controllers.

Conditions That Limits the Effectiveness of MPPT

The V_{mp} of a solar module decreases as the temperature of the module increases. In very hot weather, the V_{mp} may be close or even less than battery voltage. In this situation, there will be very little or no MPPT gain compared to traditional controllers. However, systems with modules of higher nominal voltage than the battery bank will always have an array V_{mp} greater than battery voltage. Additionally, the savings in wiring due to reduced solar current make MPPT worthwhile even in hot climates.

4.2 Battery Charging Information

Four Charging Stage

The Tracer has a 4-stage battery charging algorithm for rapid, efficient, and safe battery charging.

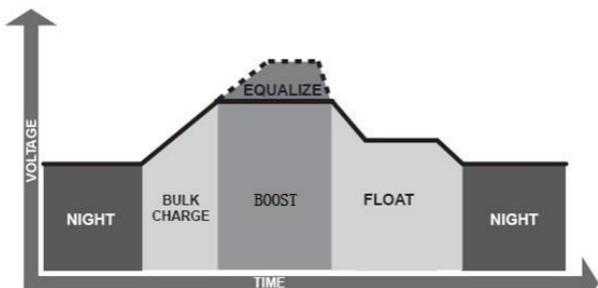

Figure 4-2 Tracer MPPT charging algorithm

Bulk Charge

In this stage, the battery voltage has not yet reached boost voltage and 100% of available solar power is used to recharge the battery

Boost Charge

When the battery has recharged to the Boost voltage setpoint, constant-voltage regulation is used to prevent heating and excessive battery gassing. The Boost stage remains 120 minutes and then goes to Float Charge. Every time when the controller is powered on, if it detects neither over discharged nor overvoltage, the charging will enter into boost charging stage.

Float Charge

After the Boost voltage stage, Tracer will reduce the battery voltage to Float voltage setpoint. When the battery is fully recharged, there will be no more chemical reactions and all the charge current transmits into heat and gas at this time. Then the Tracer reduces the voltage to the floating stage, charging with a smaller voltage and current. It will reduce the temperature of battery and prevent the gassing, also charging the battery slightly at the same time. The purpose of Float stage is to offset the power consumption caused by self consumption and small loads in the whole system, while maintaining full battery storage capacity.

In Float stage, loads can continue to draw power from the battery. In the event that the system load(s) exceed the solar charge current, the controller will no longer be able to maintain the battery at the Float setpoint. Should the battery voltage remains below the boost reconnect charging voltage, the controller will exit Float stage and return to Bulk charging.

Equalize



WARNING: Risk of explosion!

Equalizing flooded battery can produce explosive gases, so well ventilation of battery box is necessary.



NOTE: Equipment damage!

Equalization may increase battery voltage to the level damaging to sensitive DC loads. Ensure that all load allowable input voltages are greater than the equalizing charging set point voltage.



NOTE: Equipment damage!

Over-charging and excessive gas precipitation may damage the battery plates and activate material shedding on them. Too high an equalizing charge or for too long may cause damage. Please carefully review the specific requirements of the battery used in the system.

Certain types of batteries benefit from periodic equalizing charge, which can stir the electrolyte, balance battery voltage and complete chemical reaction. Equalizing charge increases the battery voltage, higher than the standard complement voltage, which gasifies the battery electrolyte.

If it detects that the battery is being over discharged, the solar controller will automatically turn the battery to equalization charging stage, and the equalization charging will be 120mins. Equalizing charge and boost charge are not carried out constantly in a full charge process to avoid too much gas precipitation or overheating of battery.

4.3 LED Indications

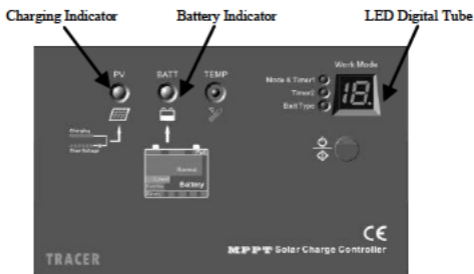

Figure 4-3 LED Indicators

• Charging Indicator

The green LED indicator will light whenever sunlight is available for battery charging, the green charging LED will stay on in normal charging. The charging LED indicator flashes when battery over voltage. Please refer to Chapter 5 for troubleshooting.

Charging LED indicator

Table4-1

Color	Indication	Operating State
Green	On Solid	Charging
Green	Flashing	Battery over-voltage

• Battery Indicator

GREEN ON when battery voltage in normal range

GREEN FLASHING when battery full

ORANGE ON when battery under voltage

RED ON when battery over discharged

Please refer to Chapter 5 for troubleshooting

Battery LED indicator

Table 4-2

Color	Indication	Operating State
Green	On solid	Normal (battery)
Green	Flashing	Full (battery)
Orange	On solid	Under voltage(battery)
Red	On solid	Over discharged(battery)

• PV Overvoltage Display

If the solar input open circuit voltage (V_{oc}) exceeds the maximum rating, the array will remain disconnected until the V_{oc} falls safely below the maximum rating.

PV Overvoltage LED Display

Table 4-3

Color	Indication	Operating State
Red	LED digital tube displays "P"	PV Overvoltage

• PV Overcurrent Display

If the solar input current exceeds the maximum rating, the array will be disconnected automatically

PV Overcurrent LED Display

Table 4-4

Color	Indication	Operating State
Red	LED digital tube displays “C”	PV Overcurrent

• Load indicator

When the load amp is 1.25 times of rated current for 60 seconds, or the load amp is 1.5 times of rated current for 5 seconds (overload); or load short circuit, the Battery Indicator RED FLASHING Please refer to section 5 for troubleshooting

Load LED indicator

Table 4-5

Color	Indication	Load status
Red	battery indicator red flashing	Overload or Short circuit

4.4 Setting Operation

• Dual Timer Function

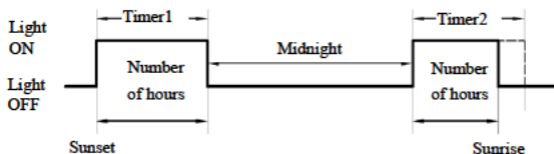

The default night length is 10 hours. The controller can learn the night length referring to the previous night so as to adapt to the different seasons. However, it will take some time to learn it.



Notes: when the “OFF” time set at timer 2 is later than local sunrise time, the controller will turn off the load output at the sunrise time, which shows light control first!

• Load Control Settings

1 Dusk to Dawn (Light ON + Light OFF)

When solar module voltage goes below the point of NTTV (Night Time Threshold Voltage) at sunset, the solar controller will recognize the starting voltage and turn on the load after 10 minutes delay. When solar module voltage goes above point of DTTV (Day Time Threshold Voltage), the solar controller will recognize the starting voltage and turn off the load after 10 minutes delay.

2 Light ON + Timer (1-15h on)

When solar module voltage goes below the point of NTTV (Night Time Threshold Voltage) at sunset, the solar controller will recognize the starting voltage and turn on the load after 10 minutes delay for several hours which users set on the timer. The timer setting operation is referred to as “Load Work Mode Setting”.

3 Test Mode

It is used to test the system and the same as Dusk to Dawn. But there is no 10 minutes delay when controller recognizes the starting voltage. When below the starting voltage, the controller will turn on the load, if higher, it will turn off load. The test mode makes it easy to check the system installation.

4 Manual Mode

This mode is to turn on/off the load by Setting Switch.

• **Load Work Mode Setting**

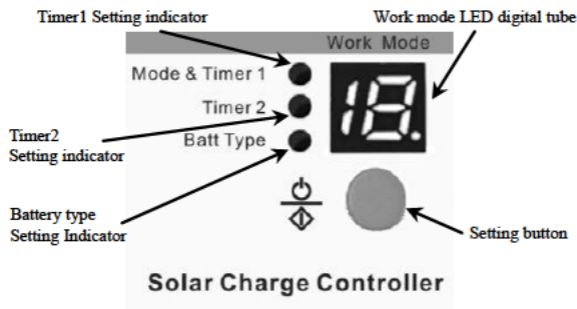

Figure 4-4 Instruction figure on setting

Press the setting button once and setting indicators will be changed once among timer 1, timer2 and battery type

When timer 1 setting indicator is on, press the setting button for more than 5 seconds till the LED digital tube flashes. Then press the setting button till the desired number appears according to the following table. The setting is finished when the digital tube stop flashing.

Timer 2 setting is the same as timer 1 when the setting indicator is on timer2

Timer1	LED Digital No
Disable	n
Dusk to Dawn, Load will be on all night	0
Load will be on for 1 hour after ten minutes delay since sunset	1
Load will be on for 2 hours after ten minutes delay since sunset	2
Load will be on for 3 hours after ten minutes delay since sunset	3
Load will be on for 4 hours after ten minutes delay since sunset	4
Load will be on for 5 hours after ten minutes delay since sunset	5
Load will be on for 6 hours after ten minutes delay since sunset	6
Load will be on for 7 hours after ten minutes delay since sunset	7
Load will be on for 8 hours after ten minutes delay since sunset	8
Load will be on for 9 hours after ten minutes delay since sunset	9
Load will be on for 10 hours after ten minutes delay since sunset	10
Load will be on for 11 hours after ten minutes delay since sunset	11
Load will be on for 12 hours after ten minutes delay since sunset	12
Load will be on for 13hours after ten minutes delay since sunset	13
Load will be on for 14 hours after ten minutes delay since sunset	14
Load will be on for 15 hours after ten minutes delay since sunset	15
Test mode	16
ON/OFF mode	17

Timer2	LED Digital No
Disable	n
Load will be on for 1 hour before sunrise	1
Load will be on for 2 hours before sunrise	2
Load will be on for 3 hours before sunrise	3
Load will be on for 4 hours before sunrise	4
Load will be on for 5 hours before sunrise	5
Load will be on for 6 hours before sunrise	6
Load will be on for 7 hours before sunrise	7
Load will be on for 8 hours before sunrise	8
Load will be on for 9 hours before sunrise	9
Load will be on for 10 hours before sunrise	10
Load will be on for 11 hours before sunrise	11
Load will be on for 12 hours before sunrise	12
Load will be on for 13hours before sunrise	13
Load will be on for 14 hours before sunrise	14
Load will be on for 15 hours before sunrise	15



Notes: If timer 1 is Dusk to Dawn(0), Test mode (16) or ON/OFF mode (17), the timer 2 will be disabled(n).

• Battery Type Setting

Press Setting Button and hold on 5 seconds when the LED is on battery type setting mode The led will be flashing Continue to press and the number will repeat from 1 to 3, and stop pressing until the desired number appears according to the following setting table:

Battery type setting

Table 4-8

Battery type	Digital tube display
Sealed lead acid battery	1
Gel battery	2
Flooded battery	3

5 Protections, Troubleshooting and Maintenance

5.1 Protection

PV Array Short Circuit

If PV array short circuit occurs, clear it to resume normal operation

PV Overvoltage

If PV Overvoltage occurs, the array will remain disconnected until the voltage falls safely below the maximum rating

PV Overcurrent

If PV Overcurrent occurs, the array will be disconnected automatically

Load Overload

If the load current exceeds the maximum load current rating, the controller will disconnect the load. Overloading must be cleared up through reapply power or pressing the setting button

Load Short Circuit

Fully protected against load wiring short-circuit. After one automatic load reconnect attempt, the fault must be cleared by reapply power or pressing the setting button

PV Reverse Polarity

Fully protection against PV reverse polarity, no damage to the controller will result. Correct the miswire to resume normal operation

Battery Reverse Polarity

Fully protection against battery reverse polarity, no damage to the controller will result. Correct the miswire to resume normal operation

Damaged Local Temperature Sensor

If the temperature sensor short-circuited or damaged, the controller will be charging or discharging at the default temperature 25°C to prevent the battery damaged from overcharging or over discharged

High Voltage Transients

PV is protected against high voltage transients. In lightning prone areas, additional external suppression is recommended

5.2 Troubleshooting

Trouble Shooting

Table 5-1

Faults	Possible reasons	Troubleshooting
Charging LED indicator off during daytime when sunshine falls on PV modules properly	PV array disconnection	Check that PV and battery wire connections are correct and tight
Green charging LED indicator flashing	Battery voltage higher than over voltage disconnect voltage(OVD)	Check if battery voltage over high Disconnect the solar module
Battery LED indicator are orange	Battery under voltage	Load output is normal,, charging LED indicator will return to green automatically when fully charged
Battery LED indicator RED color	Battery over discharged	The controller cut off the output automatically, LED indicator will return to green automatically when fully charged
LED digital tube displays "P"	PV Overvoltage	Check whether the PV parameters match with the controller's; It will be reconnected automatically until the voltage falls safely below the maximum rating
LED digital tube displays "C"	PV Overcurrent	Check whether the PV parameters match with the controller's, please according to the controller parameters for photovoltaic parameters selection
Battery Indicator red flashing	Over load or short circuit	Overload: Please reduce the load and press the button once, the controller will resume to work after 3s; Short circuit: when the first short-circuit occurs, the controller will automatically resume to work after 10s; when a second short-circuit occurs, press the button, the controller will resume to work after 3s

5.3 Maintenance

The following inspections and maintenance tasks are recommended at least two times per year for best controller performance

- Check that the controller is securely mounted in a clean and dry environment
- Check that the air flow and ventilation around the controller is not blocked. Clear all dirt or fragments on the heat sink
- Check all the naked wires to make sure insulation is not damaged for serious solarization, frictional wear, dryness, insects or rats etc. Maintain or replace the wires if necessary
- Tighten all the terminals. Inspect for loose, broken, or burnt wire connections
- Check and confirm that LED digital tube is consistent with required. Pay attention to any troubleshooting or error indication. Take necessary corrective action
- Confirm that all the system components are ground connected tightly and correctly
- Confirm that all the terminals have no corrosion, insulation damaged, high temperature or burnt/discolored sign, tighten terminal screws to the suggested torque
- Inspect for dirt, insects and corrosion, and clear up
- Check and confirm that lightning arrester is in good condition. Replace a new one in time to avoid damaging of the controller and even other equipments



Warning: Risk of electric shock!

Make sure all the power is turned off before above operations, and then follow the corresponding inspections and operations.

6 Warranty

The Tracer charge controller is warranted to be free from defects for a period of TWO (2) years from the date of shipment to the original end user. We will, at its option, repair or replace any such defective products.

• **Claim procedure:**

Before requesting warranty service, check the Operation Manual to be certain that there is a problem with the controller. Return the defective product to us with shipping charges prepaid if problem cannot be solved. Provide proof of date and place of purchase. To obtain rapid service under this warranty, the returned products must include the model, serial number and detailed reason for the failure, the module type and size, type of batteries and system loads. This information is critical to a rapid disposition of your warranty claim.

• **This warranty does not apply under the following conditions:**

- 1 Damage by accident, negligence, abuse or improper use
- 2 PV or load current exceeding the ratings of product
- 3 Unauthorized product modification or attempted repair
- 4 Damaged occurring during shipment
- 5 Damage results from acts of nature such as lightning, weather extremes
- 6 Irreclaimable mechanical damage

7 Technical Specifications

• Electrical Parameters

Description	Parameter
Nominal System Voltage	12VDC / 24VDC Auto work
Rated Battery Current	20A
Maximum Battery Voltage	32V
Max Solar Input Voltage	Tracer-2210RN 100VDC Tracer-2215RN 150VDC
Max PV input power	12V / 260W 24V / 520W
Self-consumption*	<10mA(24V)
Charge Circuit Voltage Drop	≤0.26V
Discharge Circuit Voltage Drop	≤0.15V
Communication	TTL232 / 8pin RJ45

* Charging & discharging circuit closed, LED digital tube OFF, remote meter MT-5 disconnected.

• Battery Parameters (Tem: 25℃)

Control Parameter			
Battery charging setting	Gel	Sealed	Flooded
High Volt Disconnect	16V; x2/24V	16V; x2/24V	16V; x2/24V
Charging limit voltage	15.5V; x2/24V	15.5V; x2/24V	15.5V; x2/24V
Over Voltage Reconnect	15V; x2/24V	15V; x2/24V	15V; x2/24V
Equalization voltage	—	14.6V; x2/24V	14.8V; x2/24V
Boost voltage	14.2V; x2/24V	14.4V; x2/24V	14.6V; x2/24V
Float voltage	13.8V; x2/24V	13.8V; x2/24V	13.8V; x2/24V
Boost return voltage	13.2V; x2/24V	13.2V; x2/24V	13.2V; x2/24V
Low voltage reconnect	12.6V; x2/24V	12.6V; x2/24V	12.6V; x2/24V
Under voltage recover	12.2V; x2/24V	12.2V; x2/24V	12.2V; x2/24V
Under voltage warning	12V; x2/24V	12V; x2/24V	12V; x2/24V
Low voltage disconnect	11.1V; x2/24V	11.1V; x2/24V	11.1V; x2/24V
Discharging limits voltage	10.8V; x2/24V	10.8V; x2/24V	10.8V; x2/24V
Equalize duration	—	2hours	2hours
Boost duration	2hours	2hours	2hours

• **Threshold Voltage**

Description	Parameter
NTTV (Night Time Threshold Voltage)	5V; x2/24V
DTTV (Day Time Threshold Voltage)	6V; x2/24V

• **Temp compensation**

Description	Parameter
Temperature Compensation Coefficient(TEMPCO)*	-30mV/°C/12V (25°C ref)

* **Compensation of equalize, boost, float and low voltage disconnect voltage.**

• **Environmental Parameters**

Environmental	Parameter
Ambient temperature range	-35 °C to +55°C
Storage temperature range	-35°C to +80°C
Humidity range	10%-90%(NC)
Enclosure	IP30
Altitude	≤3000 m

• **Mechanical Parameters**

Mechanical	Parameter
Dimension	169 x 118 x 83 / mm
Mounting holes	160 x 80 / mm
Mounting hole size	Φ5
Terminal	10mm ²
Weight	0.95kg

Final interpretation right of the manual belongs to our company.

Any changes without prior notice

PV Power — Conversion Efficiency Curve

Illumination Intensity: 1000W/m^2 Temperature: 25°C

Tracer-2210RN:

1 Solar Module MPP Voltage(17V) / Nominal System Voltage(12V)

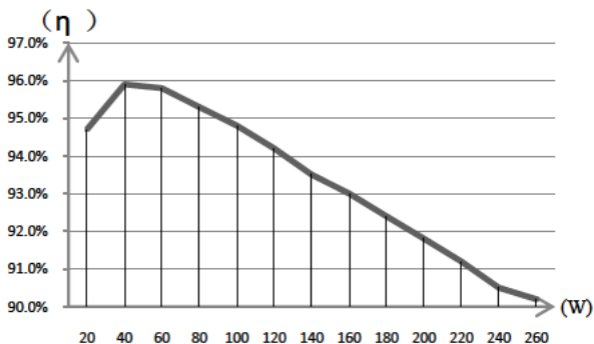

2 Solar Module MPP Voltage(34V) / Nominal System Voltage(12V)

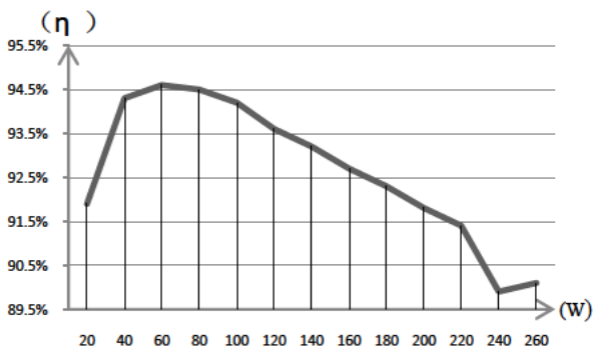

3 Solar Module MPP Voltage(68V) / Nominal System Voltage(12V)

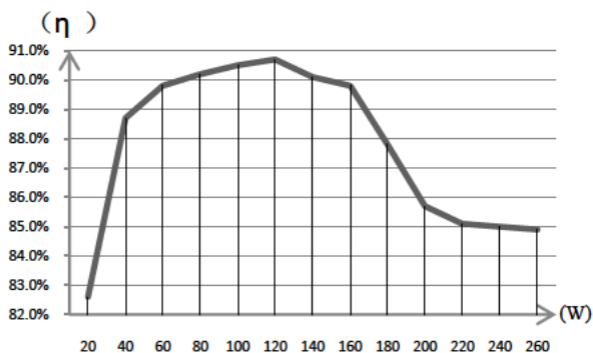

4 Solar Module MPP Voltage(34V) / Nominal System Voltage(24V)

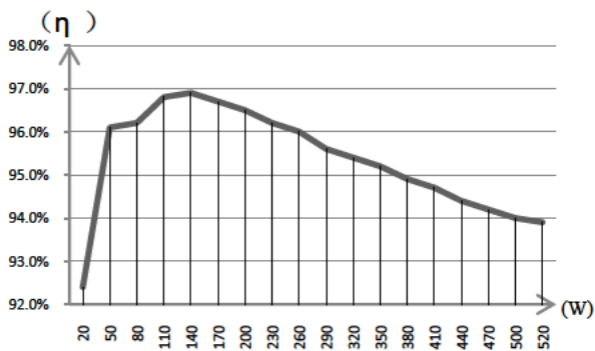

5 Solar Module MPP Voltage(68V) / Nominal System Voltage(24V)

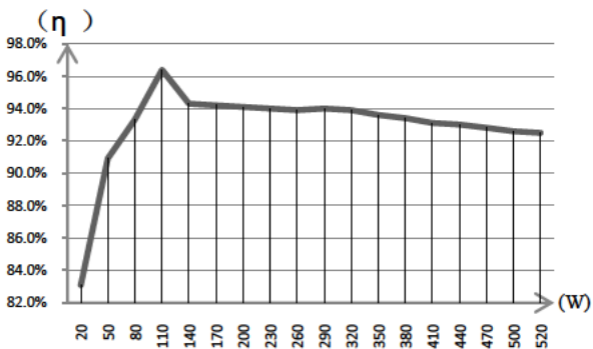

Tracer Dimensions (mm)

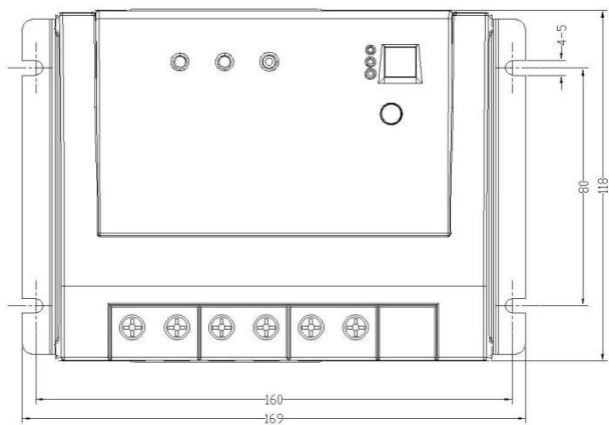
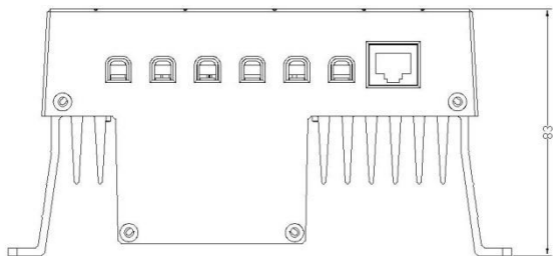

Tracer-2210RN / 2215RN



BEIJING EPSOLAR TECHNOLOGY CO., LTD.

Tel: 010-82894112 / 82894962

Fax: 010-82894882

E-mail: info@epsolarpv.com

Website: www.epsolarpv.com

