

Getting started with

ONL[®] *i*ntuition-e

Electricity consumption monitoring – single phase for homes and some smaller light commercial premises

OVERVIEW:

The OWL Intuition-e electricity monitoring system comprises of three major components:

- Electricity monitoring Sensor clamp and wireless Transmitter.
- Internet interface – Network OWL wireless gateway.
- User interface – A web browser or smart phone app.

IN THE BOX:

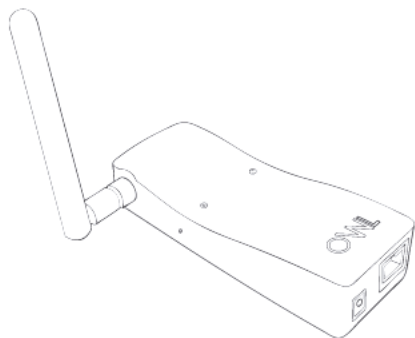

Network OWL gateway with external antenna

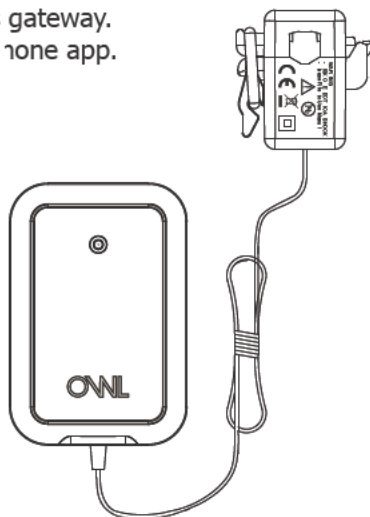

Transmitter unit fitted with a standard Sensor clamp (<10mm cable, <71A)

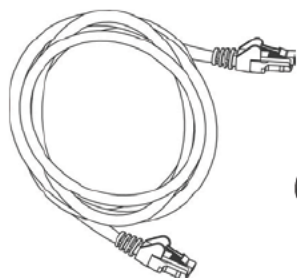

Ethernet cable

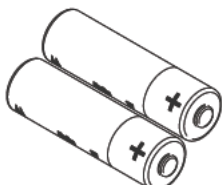

2 x AA alkaline battery

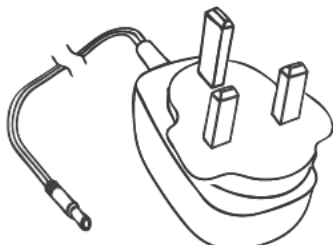

Plug top mains power supply (100 - 240V AC / 5V DC) with UK and Euro adaptors

BEFORE YOU START

Please locate and check that you have a spare LAN port available on the back of your broadband Internet router. You will need to plug in the supplied Ethernet cable. If all of the ports are in use, you can add more connections by purchasing an Ethernet Switch / Hub.

You will also need a spare mains socket available close by for the supplied Plug top mains power supply.



STEP ONE - Insert batteries into the Transmitter

Slide back cover off of the Transmitter and insert the batteries into the unit. Keep the Transmitter with you alongside the Network OWL until Step Six. You should NOT fit the Sensors at this time.

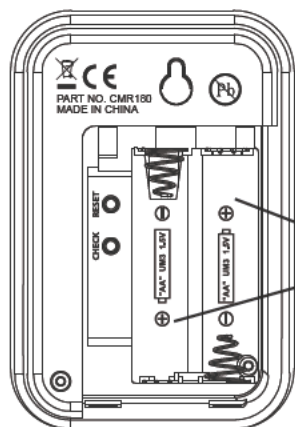

INSERT 2 x AA BATTERY

STEP TWO - Power up Network OWL

- Ensure antenna is screwed, finger tight, onto brass connector on side of the Network OWL.
- Select UK or Euro adaptor as required. Fit to the power supply and rotate 90° until it latches into place.

- Plug the power supply into the mains and insert the DC jack connector into the base of the Network OWL.

- The green LED will flash rapidly. After about 30 seconds the blue LED will start a steady flash indicating that it is in Pairing Mode.

- Quickly move to Step Three.

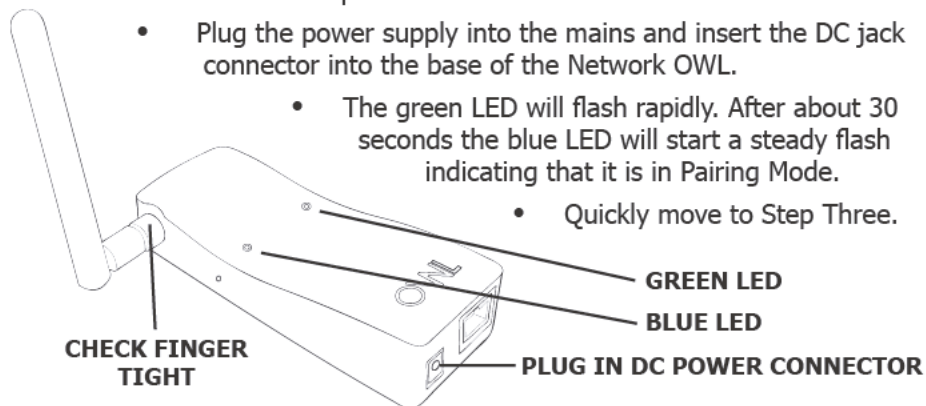

STEP THREE - Pair Transmitter to the Network OWL

- Ensure the Transmitter is next to the Network OWL.
- Press the small "Check" button in the Transmitter battery compartment until the red LED on the front starts flashing.
- The Transmitter is now in Check Mode and the red LED on the front will start flashing every 2 seconds (for 30 seconds).
- The pairing process will now take place and the blue LED will start flashing a fraction of a second after the red LED flashes.
- When the Transmitter Check Mode finishes, if the pairing was successful, the blue LED will flash every time it receives data from the Transmitter (every 12 to 60 seconds).
- Replace battery compartment cover.

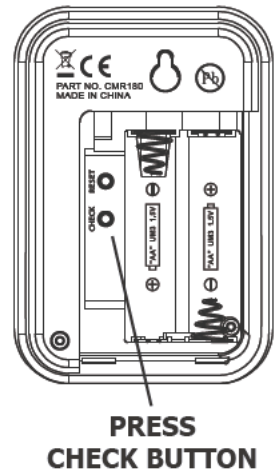

IMPORTANT Pairing Notes & Network OWL Factory Reset:

- If you don't complete the pairing process within 60 seconds of the Network OWL blue LED starting its steady flash, restart the process by removing and re-inserting the DC power jack.
- You can quickly check for correct pairing at any time by pressing the Transmitter "Check" button until the red LED starts flashing - if the Transmitter red LED and Network OWL blue LED flash together they are correctly paired.
- If you remove / change the Transmitter batteries you will need to remove the existing pairing from the Network OWL and pair the Transmitter again. To clear ALL pairings in the Network OWL including other paired devices such as heating controls, carry out a full Factory Reset as follows:

- Factory Reset the Network OWL by pressing the reset button while the power is on. Carefully insert a paperclip into the small hole and hold the button pressed for a minimum of 10 seconds and release. The green LED will flash rapidly. After about 30 seconds the blue LED will start a steady flash indicating that it is in Pairing Mode. After each Factory Reset you must go through Step Seven, the Web Dashboard "Create Account" process again, but ticking "Account Exists".

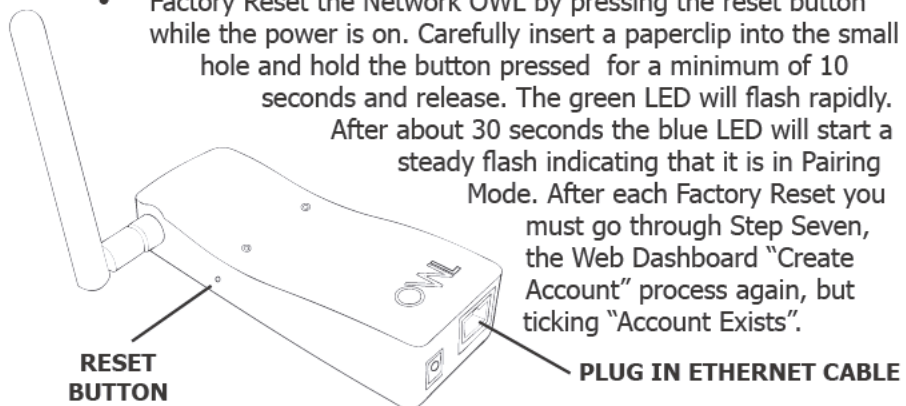

STEP FOUR - Connect Network OWL to the Internet

- Plug the Ethernet cable into the base of the Network OWL and a spare LAN port on your existing broadband Internet router.
- Ensure the connector latches with an audible “click” at both ends and that there is activity on the green & yellow LEDs above the Ethernet connector.
- Ensure so far as possible that there are no large metal objects in the radio (direct) path between installed locations of the Network OWL and the Transmitter. The wireless range is up to 30 metres (free space). Walls and large objects will reduce this range.

Note: The table below describes the meanings of the LEDs visible on the front face of the Network OWL.

Network OWL LED Meanings		
LED	Pattern	Meaning
Blue	Steady flash following power up	N-OWL is in pairing mode
Blue	Flash every 12 to 60 seconds	Data received from paired Transmitter
Blue	Off for longer than 60 seconds	N-OWL is <u>not</u> paired or Transmitter is out of radio range
Green	Rapid flashing	N-OWL is starting up
Green	Single blip	N-OWL is running
Green	Double blip	N-OWL is running & Connected to LAN, DHCP IP address allocated
Green	Triple blip	N-OWL is running & Connected to LAN, DHCP IP address allocated & Connected to OWL servers (N-OWL Online)
Green	Single long flash	Connecting to OWL log servers
Green	Double long flash	Uploading logged data to OWL servers

STEP FIVE - Wait 2 mins for Network OWL to come online

- Once the Ethernet cable has been connected you should see the green LED quickly progress from single blips to double blips.
- It will now normally take up to 2 minutes for the Network OWL to securely connect to the OWL servers, indicated by a triple blip on the green LED.
- Do not progress to Step Six until the Network OWL is online.

IMPORTANT Internet Connection Notes:

- The Network OWL can normally connect to the OWL servers when plugged into a normal domestic broadband router which has a default security configuration.
- If the Network OWL does not connect within 5 minutes:
 - a. Ensure that your Internet connection is working by connecting to a

familiar site using your web browser.

- b. Check Ethernet cable connections - remove cable and refit a few times at both ends to remove any dust on the connections.
- c. Try rebooting your broadband router by powering down for 10 seconds and then power back up. Allow 5 minutes for everything to re-establish itself.

IMPORTANT Note for business users:

- If you wish to use a Network OWL connected to a business / commercial LAN then please note that it is usual for the internal IT Security Department to restrict which Internet ports are open for use.
- You will need to ensure that ports numbered 5004 and 5222 are opened outbound. Without this the Network OWL will not be able to connect to the OWL servers and your Intuition system will not function.

STEP SIX - Install Transmitter and attach Sensor

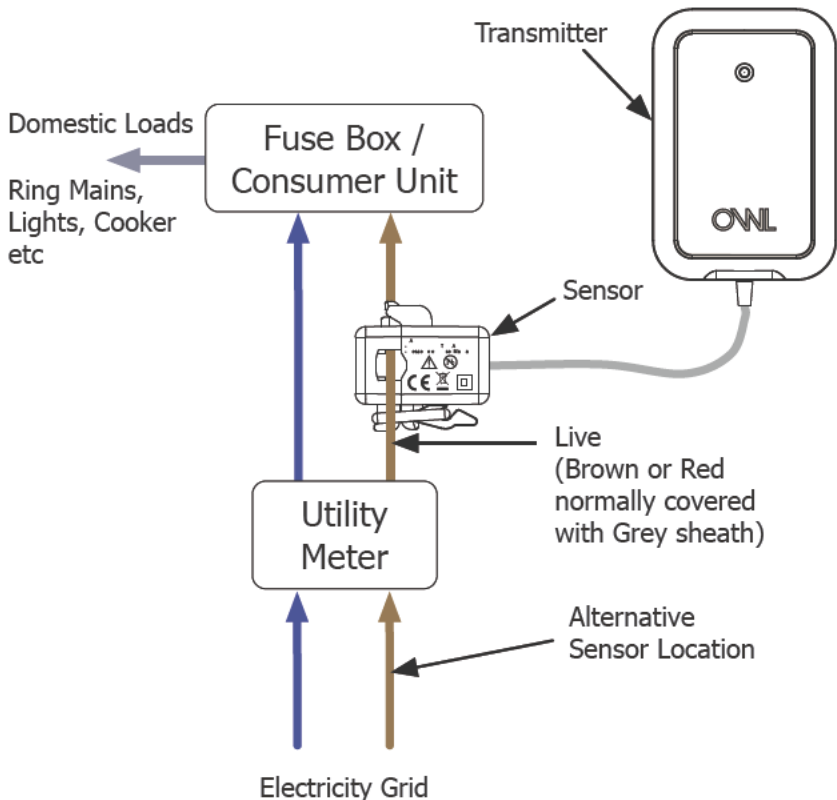

Intuition-e Transmitter & Sensor

- Locate the supply cables between your electricity meter and consumer unit (fuse box). See diagram above.
- Using the latch, clamp the Sensor around the insulated Live cable going into the meter – Live cable either side of meter is acceptable.
- The Sensor must be a loose fit onto the cable. A larger clamp is available for purchase from www.theowl.com.
- The Transmitter should be hung on the wall in a free area as far from large metal objects as possible.

STEP SEVEN - Create Intuition online account

- Using the web browser on your computer open up the following page: **<https://www.owlintuition.com>** (this is a secure connection).
- Click "Create Account" and fill in the information requested (see following table for explanation of the information required).
- Ensure you correctly select the system type as Intuition-e
- Press the "Create Account" button.
- Successful account creation and configuration will be confirmed.
- Please keep a note of your details and press the "Finish" button.

Account Set Up Information Required

Item	Value	Notes
Username	Letters & digits	Choose a memorable account username a minimum of 6 characters long. <u>Not</u> case sensitive.
Password	Letters & digits	Choose a memorable password a minimum of 6 characters long. Password <u>is</u> case sensitive.
Email	Valid email address	Enter the email address you wish us to be able to contact you on.
Network OWL ID	12 characters	MAC ID can be found on back of the Network OWL and starts 443719..... Enter the full 12 characters.
Country	Select from list	The country where this OWL Intuition system is physically installed.
Timezone	Select from list	The time zone where this OWL Intuition system is physically installed.
Use Daylight Saving	Tick	Tick this box to enable automatic adjustment for daylight saving. (Not available for all countries.)
Currency	Select from list	Select the currency symbols to be used by this account.
Voltage	100 to 260	Enter the normal voltage of the system being monitored. Default is 230 volts.

Item	Value	Notes
Postcode	Letters & digits	UK only - enter just the first part of your postcode eg. For RG24 9LR just enter RG24.
Town	Letters	Outside UK only - enter the name of the nearest Town or City to where this OWL Intuition system is physically installed.
System Type	Select from list	<u>Intuition-e</u>

STEP EIGHT - Log in to your OWL Intuition account

You can now log in to your OWL Intuition account with your new username and password at: <https://www.owlintuition.com>

IMPORTANT: Before progressing please check the signal strength of the radio signal between your Transmitter and Network OWL. Also it is recommended that you enter your own Tariff details which can be accessed by pressing the Settings "gear wheels" icon on the Electricity widget.

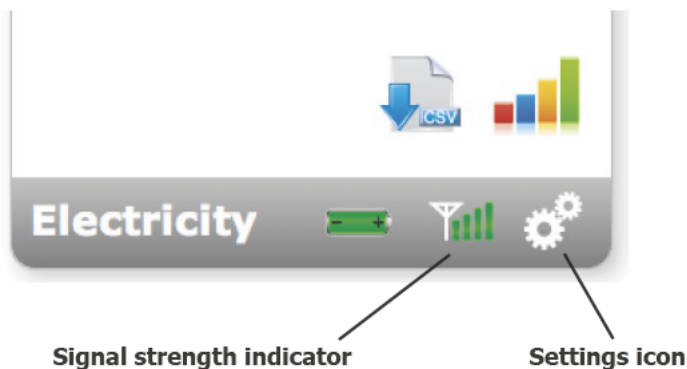

If the signal strength is only 1 or 2 bars, to reduce the chance of intermittent / inconsistent data reception it is suggested that you reposition the Network OWL so that it is physically closer to the Transmitter.

The Network OWL should ideally be hung on the wall in a free area as far from large metal objects as possible. Position the antenna in a vertical orientation.

If necessary you can replace the Ethernet cable with a longer cable (up to 100 meters long). If installing a long Ethernet cable is a problem, you can use a "Powerline Range Extender" or "Wireless Range Extender" - please search for these common products online.

INFORMATION & TROUBLE SHOOTING TIPS

- Unless the Transmitter is in Check Mode, the red LED does not flash, in order to prolong battery life.
- Check that the blue LED on the Network OWL flashes every 12 seconds if the monitored electricity supply consumption is varying, or every 60 seconds when at a steady state.
- If the blue LED does not flash then the Transmitter signal is not being received or the Transmitter Pairing has been lost. Undo the Transmitter's Sensor and move them so they are near to the Network OWL to confirm radio range is not an issue.
- For wireless range testing you can make the Transmitter send its signal every 2 seconds (for 30 seconds) by pressing the "Check" button in the battery compartment for 10 seconds. The red LED will flash with each transmission, the Network OWL blue LED will flash to confirm the signal has been received.
- Network OWL Ethernet port LEDs have the following meanings: Green – link ok / up; Yellow – data activity.

WEB BROWSER INTERFACE - All versions

Overview

Designed to be clear and easy to use, you are encouraged to explore the various information panels, called "Widgets", that you have available. The Widgets available will vary, depending upon the system options you have purchased. Clicking on the arrows on the left and right of the screen will scroll between your Widgets if required.

Messages

OWL Intuition system messages and EcoNudge™ (when available) will be posted into your Inbox. A green numbered badge will appear next to this menu bar item when you have unread messages. For maximum benefit please read these messages as soon after they appear as possible.

Shop

Clicking this menu bar item will open a new tab within your web browser and display the home page of the OWL online shop.

Logout

When you have finished using your OWL Intuition account please Logout by clicking this menu bar item. Please note you can only log in one web browser at a time. If you log in a second time then the first connection will be logged out. If you or the browser refreshes the page, you will have to log in again.

Weather

Current weather conditions for your home / building location are displayed. The location is defined by the part postcode or Town you gave during your OWL Intuition account setup. Future OWL Intuition products will use current and forecast weather to dynamically optimise energy saving.

System Status

In normal circumstances providing your broadband Internet connection is working the System should always show as being Online with a recent "last updated" time.

Widgets – General Information

There are normally 3 Widgets visible whenever you are logged into your OWL Intuition account. You can view any additional Widgets you may have by scrolling them with the arrows to the left and right of the screen. In general the top section of each Widget provides you with appropriate high level / summary information. Trend arrows appear where appropriate next to data values – if you hover your mouse point over the arrow a summary of the change will appear in a pop-up. Above the Widget title bar is one or more "action icons" that provide access to more detailed information and control options. If you

hover your mouse over one of these "action icons" a description of its function will appear. If appropriate, the grey Widget title bar has a "gear wheels" icon on the right. Clicking this icon will pop-up a window that will allow you to configure this part of the OWL Intuition system to match your specific installation. Be sure to click the "Save" button before closing the window.

Widgets - Graphs

When you click on a Graphs "action icon", a double size graph panel will appear next to the Widget.

Graph selections - Typically a graph will show relevant data for the last 7 days. You can select a shorter or longer "Time Frame" (1 day, 1 Week, 1 Month, 3 Months, 6 Months or All) by clicking the appropriate button at the top of the graph. Select an appropriate "Group By" (None, Day, Week, Month, Year), then chose the data you wish to "Display" (Energy or Cost). Finally, to update the graph with your new selections, click on the "Reload" button. Please note that not all permutations are possible and invalid options are greyed out.

Hover over analysis – By moving your mouse pointer over the graph a pop-up window will open, showing detailed values for the focus points marked on the graph. Where appropriate, date and time information for the currently displayed focus points will also be shown. Simply move the mouse pointer from left to right and the focus points and information window will automatically update.

Zoom in – If you want to take a closer look at the graph you can zoom in to the part that is of interest. Move your mouse pointer to the start of the area of interest, click and hold, drag to the end of the area of interest and release. The graph will automatically zoom in on the area selected. Click the "Reset zoom" button when finished.

Print / Download buttons – If you want to keep a hard or soft copy of the displayed graph then use the Print or Download buttons located just above the graph on the right, the CSV option here will download a file containing the data shown in the graph.

Closing the graph – After you have finished viewing the graph, simply press the X (close) icon on the Graph Widget title bar (bottom right).

Electricity Widget

Live display of your current overall electrical energy consumption in Watts / kW together with the current overall cost per hour (based upon your Tariff settings). The cost figure is adjusted for Solar PV generated power if applicable. Also shows electrical energy used / cost for Today (so far), Yesterday, Last 7 Days and Last 30 Days with trend information when available.

Action icons available:

- Electricity Data Export - Prompts for Start & End dates (up to 1 month apart). Will then download a CSV file containing detailed data recorded for this period. Download the Help file for full details.
- Electricity Graphs - Graphical views of historic Electricity usage

Status & Settings:

- Transmitter Battery - Displays "Good" or "Replace Soon"
- Transmitter Signal Strength - 1 bar (poor) to 4 bars (good)
- Settings - Tariff type, Tariff standing charge, Rate per kWh

Solar Widget

Live display of your current Solar PV electrical energy generation in Watts / kW together with the current power you are exporting to the grid. Also shows Solar PV electrical energy generated and exported for Today (so far), Yesterday, Last 7 Days and Last 30 Days with trend information when available.

Action icons available:

- Solar Graphs - Graphical views of historic Generated Solar Power, Exported Solar Power and Imported Electricity.

Status & Settings:

- FITS Tariff settings - Generation Tariff, Export Tariff & Assumed Export %

3 Phase Electricity Widget

Live display of your current overall electrical energy consumption in Watts / kW for each of your 3 individual phases. Also shows for each phase the electrical energy used for Today (so far), Yesterday, Last 7 Days and Last 30 Days.

Action icons available:

- 3 Phase Electricity Graphs - Graphical views of historic Electricity Usage for each individual phase.

Status & Settings:

- None.

Overview Widget

Electricity Yesterday - Maximum, Minimum and Average recorded consumption rates (kW).

CO₂e - Calculated CO₂ emissions in kg's for Yesterday, Last Week and Last 30 Days. Adjusted for any Solar PV electrical energy generated and consumed.

Solar Yesterday - Maximum and Average recorded Solar PV generation rates (kW) together with the amount of electrical energy (kWh) Imported from the Grid (Consumption - Generated = Imported)

Solar Financials - Financial value of electricity generated Yesterday, Last Week, Last 30 Days and Since PV system was installed.

News Widget

News and interesting articles relating to OWL products, company news and energy saving in general.

Your OWL Intuition-e system should now be set up and ready to help save energy, CO2 emissions and money.

Please check out the other products in our OWL Intuition range, such as heating controls, that extend the capability of your Intuition system.