



Tracer A Series

—MPPT Solar Charge Controller

User Manual



Models:

Tracer1206A /Tracer1210A

Tracer2210A/Tracer3210A/Tracer4210A

Important Safety Instructions

Please reserve this manual for future review. This manual contains all instructions of safety, installation and operation for Maximum Power Point Tracking (MPPT) controller in Tracer A series ("the controller" is referred in this manual).

General Safety Information

- Read carefully all the instructions and warnings in the manual before installation.
- No user serviceable component inside controller. DO NOT disassemble or attempt to repair the controller.
- Mount the controller indoors. Prevent exposure to the elements and do not allow water to enter the controller.
- Install the controller in well ventilated places, the controller's heat sink may become very hot during operation.
- Suggested to install appropriate external fuses/breakers.
- Make sure switching off all connections with PV array and the fuse/breakers close to battery before controller installation and adjustment.
- Power connections must remain tight to avoid excessive heating from a loose connection.

Information générales sur la sécurité

- Lisez toutes les instructions et précautions dans le manuel avant l'installation.
- Il n'y a aucune pièce utilisable pour l'utilisateur à l'intérieur du contrôleur. Ne démontez pas ou n'essayez pas de réparer le contrôleur.
- Montez le contrôleur en intérieur. Évitez l'exposition des éléments et ne laissez pas d'eau entrer dans le contrôleur.
- Installez le contrôleur Tracer dans un endroit bien ventilé, le dissipateur de chaleur de l'Tracer peut devenir très chaud pendant l'utilisation.
- Installez les fusibles / coupe-circuits comme indiqué.
- Déconnectez le module solaire, le chargeur et le fusible / coupe-circuit proche de la batterie avant l'installation ou le réglage du contrôleur.
- Les connexions d'alimentation doivent rester à proximité pour évier une chaleur excessive du fait d'une connexion trop lâche.

Contents

1	General Information.....	1
1.1	Overview	1
1.2	Characteristics.....	2
1.3	Accessories Instructions	3
1.4	Maximum Power Point Tracking Technology.....	3
1.5	Battery Charging Stage.....	5
2	Installation Instructions	8
2.1	General Installation Notes.....	8
2.2	PV Array Requirements	8
2.3	Wire Size.....	10
2.4	Mounting	11
3	Operation	13
3.1	Button Function	13
3.2	LCD Display	13
3.3	Parameters setting	15
4	Protections, Troubleshooting and Maintenance.....	19
4.1	Protection	19
4.2	Troubleshooting.....	20
4.3	Maintenance.....	20
5	Technical Specifications	22
	Annex I Conversion Efficiency Curves	24
	Annex II Dimensions.....	29

1 General Information

1.1 Overview

Appreciate you for choosing MPPT solar charge controller, Tracer A series. Based on common positive design and advanced MPPT control algorithm, with LCD displaying running status, this product is artistic, economical and practical.

With MPPT control algorithm, in any situation, products of this series can fast and accurately track out the best maximum power point (MPP) of photovoltaic array, in order to obtain the maximum solar energy in time, which remarkably improves energy efficiency. There is dual display function: local LCD panel and remote meter. With Modbus communication protocol interface, it is convenient for customers to expand applications and monitor in various fields like telecommunication base station, household system, street lighting system, wilderness monitoring system, etc.

All-round electronic fault self-test function and enhanced electronic protection function could furthest avoid damages on system components resulting from installation errors or system failures.

Feature:

- Advanced Maximum Power Point Tracking (MPPT) technology, with efficiency no less than 99.5%.
- High quality components, perfecting system performance, with maximum conversion efficiency of 98%.
- Ultra-fast tracking speed and guaranteed tracking efficiency.
- Accurately recognizing and tracking of multiple power points.
- Reliable automatic limit function of maximum PV input power, ensuring no overload.
- Wide MPP operating voltage range.
- 12/24VDC automatically identifying system voltage.
- LCD panel display design, dynamically displaying tool's operating data and working condition.
- Multiple load control modes: manual mode, light ON/OFF, light On+Timer and test mode.
- Support 3 charging preprogram options: Sealed, Gel, Flooded.
- Battery temperature compensation function.
- Real-time energy statistics function.
- With RS-485 communication bus interface and Modbus communication protocol, it is available to meet various communication requirements in different situations.

- Available for PC monitoring and external display unit connecting like MT50 and so on, realizing real-time data checking and parameters setting.
- Support software upgrade.

1.2 Characteristics



Figure 1-1 Tracer-A Series Characteristics

Item	Name	Item	Name
①	Mounting hole sizeΦ5	⑥	Load Terminals
②	Select Button	⑦	RS-485 Port ^②
③	RTS Port ^①	⑧	Enter Button
④	PV Terminals	⑨	LCD
⑤	Battery Terminals		

Explanations:

① Connection for a RTS (Remote Temperature Sensor) to remotely detect battery temperature.

② Monitor controller by PC, remote meter MT50 or APP and update controller software via RS485 (RJ45 interface).

1.3 Accessories Instructions

1) Remote Temperature Sensor (Model: RTS300R47K3.81A)

Acquisition of battery temperature for undertaking temperature compensation of control parameters, the standard length of the cable is 3m (length can be customized). The RTS300R47K3.81A connects to the port (3rd) on the controller.

NOTE: Unplug the RTS, the temperature of battery will be set to a fixed value 25°C.

2) Remote Meter (Model: MT50)

The digital remote meter displays system operating information, error indications, parameters setting and self-diagnostics.

3) Super Parameter Programmer (Model: SPP-02)

The SPP-02 can realize one-button setting operation which is suitable for bulk quantity products setting in the projects.

4) USB To RS-485 converter (Model: CC-USB-RS485-150U)

USB To RS-485 converter is used to monitor each controller on the network using Solar Station PC software. The length of cable is 1.5m. The CC-USB-RS485-150U connects to the RS-485 Port on the controller.

1.4 Maximum Power Point Tracking Technology

Due to the nonlinear characteristics of solar array, there is a maximum energy output point (Max Power Point) on its curve. Traditional controllers, with switch charging technology and PWM charging technology, can't charge the battery at the maximum power point, so can't harvest the maximum energy available from PV array, but the solar charge controller with Maximum Power Point Tracking (MPPT) Technology can lock on the point to harvest the maximum energy and deliver it to the battery.

The MPPT algorithm of our company continuously compares and adjusts the operating points to attempt to locate the maximum power point of the array. The tracking process is fully automatic and does not need user adjustment.

As the Figure 1-2, the curve is also the characteristic curve of the array, the MPPT technology will 'boost' the battery charge current through tracking the MPP. Assuming 100% conversion efficiency of the solar system, in that way, the following formula is established:

$$\text{Input power (P}_{PV}\text{)} = \text{Output power (P}_{Bat}\text{)}$$



$$\text{Input voltage (V}_{Mpp}\text{)} * \text{input current (I}_{PV}\text{)} = \text{Battery voltage (V}_{Bat}\text{)} * \text{battery current (I}_{Bat}\text{)}$$

Normally, the V_{Mpp} is always higher than V_{Bat} . Due to the principle of conservation

of energy, the I_{Bat} is always higher than I_{PV} . The greater the discrepancy between V_{Mpp} & V_{Bat} , the greater the discrepancy between I_{PV} & I_{Bat} . The greater the discrepancy between array and battery, the bigger reduction of the conversion efficiency of the system, thus the controller's conversion efficiency is particularly important in the PV system.

Figure 1-2 is the maximum power point curve, the shaded area is charging range of traditional solar charge controller (PWM Charging Mode), it can obviously diagnose that the MPPT mode can improve the usage of the solar energy resource. According to our test, the MPPT controller can raise 20%-30% efficiency compared to the PWM controller. (Value may be fluctuant due to the influence of the ambient circumstance and energy loss.)

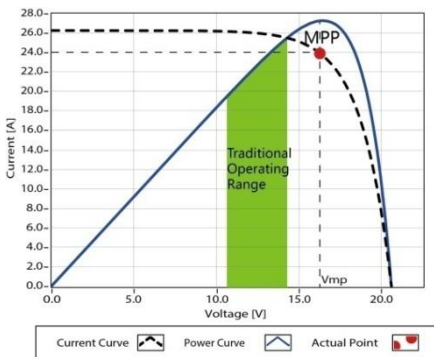

Figure 1-2 Maximum Power Point Curve

In actual application, as shading from cloud, tree and snow, the panel maybe appear Multi-MPP, but in actually there is only one real Maximum Power Point. As the below Figure 1-3 shows:

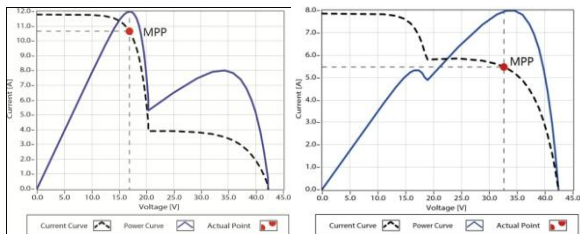

Figure 1-3 Mutil-MPP Curve

If the program works improperly after appearing Multi-MPP, the system will not work on the real max power point, which may waste most solar energy resources and seriously affect the normal operation of the system. The typical MPPT algorithm, designed by our company, can track the real MPP quickly and accurately, improve the utilization rate of the array and avoid the waste of resources.

1.5 Battery Charging Stage

The controller has a 3 stages battery charging algorithm (Bulk Charging, Constant Charging and Float Charging) for rapid, efficient, and safe battery charging.

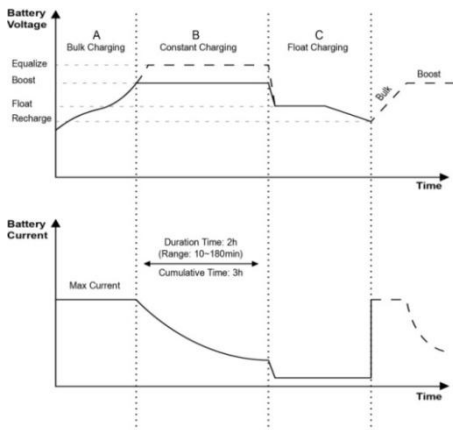

Figure 1-4 Battery changing stage Curve

A) Bulk Charging

In this stage, the battery voltage has not yet reached constant voltage (Equalize or Boost Voltage), the controller operates in constant current mode, delivering its maximum current to the batteries (MPPT Charging).

B) Constant Charging

When the battery voltage reaches the constant voltage setpoint, the controller will start to operate in constant charging mode, this process is no longer MPPT charging, and in the meantime the charging current will drop gradually, the process is not the MPPT charging. The Constant Charging has 2 stages, equalize and boost. These two stages are not carried out constantly in a full charge process to avoid too much gas precipitation or overheating of battery.

➤ Boost Charging

The Boost stage maintain 2 hours in default, user can adjust the constant time and preset value of boost voltage according to demand.

The stage is used to prevent heating and excessive battery gassing.

➤ Equalize Charging



WARNING: Explosive Risk!

Equalizing flooded battery would produce explosive gases, so well ventilation of battery box is recommended.



CAUTION: Equipment damage!

Equalization may increase battery voltage to the level that damages sensitive DC loads. Verify that all load allowable input voltages are 11% greater than the equalizing charging set point voltage.



CAUTION: Equipment damage!

Over-charging and excessive gas precipitation may damage the battery plates and activate material shedding on them. Too high an equalizing charge or for too long may cause damage. Please carefully review the specific requirements of the battery used in the system.



AVERTISSEMENT: Risque d'explosion!

l'égalisation de batteries noyées peut produire des gaz explosifs, donc il est recommandé de bien ventiler le boîtier de la batterie.



ATTENTION: Dégât sur l'équipement!

L'égalisation peut augmenter la tension de la batterie jusqu'à un niveau nuisible pour les charges CC sensibles. Vérifiez que la tension d'entrée autorisées de toutes les charges disponibles sont supérieures à 11% à la tension du point d'installation de chargement d'égalisation.



ATTENTION: Dégât sur l'équipement!

Un chargement excessif et une précipitation de gaz peut endommager les plaques de la batterie et la formation de matières actives dessus. Un chargement trop fort ou une égalisation prolongée peut causer des dégâts. Inspectez soigneusement les conditions spécifiques de la batterie utilisée dans le système.

Some types of batteries benefit from equalizing charge on a regular basis, which is able to stir electrolyte, balance battery voltage and accomplish chemical reaction. Equalizing charge increases battery voltage, higher than the standard complement voltage, which gasifies the battery electrolyte.

The controller will equalize the battery on 28th each month. The constant equalization period is 0~180 minutes. If the equalization isn't accomplished in one-time, the equalization recharge time will be accumulated until the set time is finished. Equalize charge and boost charge are not carried out constantly in a full charge process to avoid too much gas precipitation or overheating of battery.

NOTE:

1) Due to the influence of ambient circumstance or load working, the battery voltage can't be steady in constant voltage, controller will accumulate and calculate the time of constant voltage working. When the accumulated time reach to 3 hours, the charging mode will turn to Float Charging.

2) If the controller time is not adjusted, the controller will equalize charge battery once every month following the inner time.

C) Float Charging

After the Constant voltage stage, the controller will reduce charging current to Float Voltage setpoint. This stage will have no more chemical reactions and all the charge current transforms into heat and gas at this time. Then the controller reduces the voltage to the floating stage, charging with a smaller voltage and current. It will reduce the temperature of the battery and prevent the gassing and charging the battery slightly at the same time. The purpose of Float stage is to offset the power consumption caused by self consumption and small loads in the whole system, while maintaining full battery storage capacity.

In Float charging stage, loads are able to obtain almost all power from solar panel. If loads exceed the power, the controller will no longer be able to maintain battery voltage in Float charging stage. If the battery voltage remains below the Recharge Voltage, the system will leave Float charging stage and return to Bulk charging stage.

2 Installation Instructions

2.1 General Installation Notes

- Before installation, please read through the entire installation instructions to get familiar with the installation steps.
- Be very careful when installing the batteries, especially flooded lead-acid battery. Please wear eye protection, and have fresh water available to wash and clean any contact with battery acid.
- Keep the battery away from any metal objects, which may cause short circuit of the battery.
- Explosive battery gases may come out from the battery during charging, so make sure ventilation condition is good.
- Gel, Sealed or Flooded batteries are recommended, other kinds please refer to the battery manufacturer.
- Ventilation is highly recommended if mounted in an enclosure. Never install the controller in a sealed enclosure with flooded batteries! Battery fumes from vented batteries will corrode and destroy the controller circuits.
- Loose power connections and corroded wires may result in high heat that can melt wire insulation, burn surrounding materials, or even cause fire. Ensure tight connections and use cable clamps to secure cables and prevent them from swaying in mobile applications.
- Battery connection may be wired to one battery or a bank of batteries. The following instructions refer to a singular battery, but it is implied that the battery connection can be made to either one battery or a group of batteries in a battery bank.
- Multiple same models of controllers can be installed in parallel on the same battery bank to achieve higher charging current. Each controller must have its own solar module(s).
- Select the system cables according to $5A/mm^2$ or less current density in accordance with Article 690 of the National Electrical Code, NFPA 70.

2.2 PV Array Requirements

➤ Serial connection (string) of PV modules

As the core component of PV system, controller could be suitable for various types of PV modules and maximize converting solar energy into electrical energy. According to the open circuit voltage (V_{oc}) and the maximum power point voltage (V_{Mpp}) of the MPPT controller, the series number of different types PV modules can be calculated. The below table is for reference only.

Tracer1206A:

System voltage	36cell Voc<23V		48cell Voc<31V		54cell Voc<34V		60cell Voc<38V	
	MAX.	Best	MAX.	Best	MAX.	Best	MAX.	Best
12V	2	2	1	1	1	1	1	1
24V	2	2	-	-	-	-	-	-

System voltage	72cell Voc<46V		96cell Voc<62V		Thin-Film Module Voc>80V
	MAX.	Best	MAX.	Best	
12V	1	1	-	-	-
24V	1	1	-	-	-

Tracer1210A/Tracer2210A/Tracer3210A/Tracer4210A:

System voltage	36cell Voc<23V		48cell Voc<31V		54cell Voc<34V		60cell Voc<38V	
	MAX.	Best	MAX.	Best	MAX.	Best	MAX.	Best
12V	4	2	2	1	2	1	2	1
24V	4	3	2	2	2	2	2	2

System voltage	72cell Voc<46V		96cell Voc<62V		Thin-Film Module Voc>80V
	MAX.	Best	MAX.	Best	
12V	2	1	1	1	1
24V	2	1	1	1	1

NOTE: The above parameter values are calculated under standard test conditions (STC (Standard Test Condition): Irradiance 1000W/m², Module Temperature 25°C, Air Mass1.5.)

➤ **PV array maximum power**

This MPPT controller has a limiting function of charging current, the charging current will be limited within rated range, therefore, the controller will charge the battery with the rated charging power even if the input power at the PV exceeds.

The actual operation power of the PV array conforms to the conditions below:

- 1) PV array actual power ≤ controller rated charge power, the controller charge battery at actual maximum power point.
- 2) PV array actual power > controller rated charge power, the controller charge battery at rated power.

If the PV array higher than rated power, the charging time at rated power to battery will be longer, more energy to battery yields.



WARNING: Controller will be damaged when the PV array straight polarity and the actual operation power of the PV array is three times greater than the rated charge power!



WARNING: Controller will be damaged when the PV array reverse polarity and the actual operation power of the PV array is 1.5 times greater than the rated charge power!

When the PV array straight polarity, the actual operation of the PV array must NOT exceed three times of rated charge power: When the PV array reverse polarity, the actual operation must NOT exceed 1.5 times. For real application please refer to the table below:

Model	Rated Charge Current	Rated Charge Power	Max. PV Array Power	Max. PV open circuit voltage
Tracer1206A	10A	130W/12V 260W/24V	390W/12V 780W/24V	46V ^① 60V ^②
Tracer1210A	10A	130W/12V 260W/24V	390W/12V 780W/24V	92V ^① 100V ^②
Tracer2210A	20A	260W/12V 520W/24V	780W/12V 1560W/24V	
Tracer3210A	30A	390W/12V 780W/24V	1170W/12V 2340W/24V	
Tracer4210A	40A	520W/12V 1040W/24V	1560W/12V 3120W/24V	

①At 25°C environment temperature

②At minimum operating environment temperature

2.3 Wire Size

The wiring and installation methods must conform to all national and local electrical code requirements.

➤ PV Wire Size

Since PV array output can vary due to the PV module size, connection method or sunlight angle, the minimum wire size can be calculated by the I_{sc} of PV array. Please refer to the value of I_{sc} in PV module specification. When the PV modules connect in series, the I_{sc} is equal to the PV module's I_{sc}. When the PV modules connect in parallel, the I_{sc} is equal to the sum of PV module's I_{sc}. The I_{sc} of PV array must not exceed the maximum PV input current, please refer to the table as below:

Model	Max. PV input current	Max. PV wire size(mm ² /AWG)
Tracer1206A Tracer1210A	10A	4/12
Tracer2210A	20A	6/10
Tracer3210A	30A	10/8
Tracer4210A	40A	16/6

NOTE: When the PV modules connect in series, the open circuit voltage of the PV array must not exceed 46V (for Tracer1206A) or 92V (for Tracer**10A) (25°C)

➤ Battery and Load Wire Size

The battery and load wire size must conform to the rated current, the reference size as below:

Model	Rated charge current	Rated discharge current	Battery wire size (mm ² /AWG)	Load wire size (mm ² /AWG)
Tracer1206A Tracer1210A	10A	10A	4/12	4/12
Tracer2210A	20A	20A	6/10	6/10
Tracer3210A	30A	30A	10/8	10/8
Tracer4210A	40A	40A	16/6	16/6

NOTE: The wire size is only for reference. If there is a long distance between the PV array and the controller or between the controller and the battery, larger wires can be used to reduce the voltage drop and improve performance.

2.4 Mounting



CAUTION: The controller requires at least 150mm of clearance above and below for proper air flow. Ventilation is highly recommended if mounted in an enclosure.



WARNING: Risk of explosion! Never install the controller in a sealed enclosure with flooded batteries! Do not install in a confined area where battery gas can accumulate.



WARNING: Risk of electric shock!
Exercise caution when handling solar wiring. The solar PV array can produce open-circuit voltages in excess of 100V when in sunlight. Pay more attention to it.



ATTENTION: Le contrôleur Tracer nécessite au moins un espace libre de 150mm au dessus et en dessous pour une circulation correcte de l'air. Une ventilation est hautement recommandée en cas d'installation dans un boîtier.



AVERTISSEMENT: Risque d'explosion ! N'installez jamais le Tracer dans un boîtier fermé avec des batteries noyées! N'installez pas dans un espace confiné où des gaz de batterie peuvent s'accumuler.



AVERTISSEMENT: Risque d'électrochoc!
Faites attention lors de la manipulation des connexions solaires. La matrice PV solaire peut produire des tensions supérieures à 100V, à la lumière du soleil. Soyez particulièrement attentif à cela.

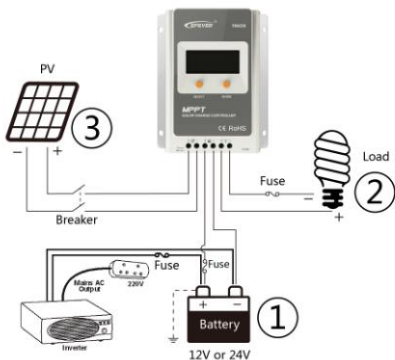

Figure 2-1 Mounting

- 1) Connect components to the charge controller in the sequence as shown above and pay much attention to the "+" and "-". Please don't turn on the fuse during the installation. When disconnecting the system, the order will be reserved.
- 2) After installation, power the controller and check the LCD on. If it's not on, please refer to chapter 4. Always connect the battery first, in order to allow the controller to recognize the system voltage.
- 3) The battery fuse should be installed as close to battery as possible. The suggested distance is within 150mm.
- 4) The Tracer A series is a positive ground controller. Any positive connection of solar, load or battery can be earth grounded as required.



CAUTION: Unplug the RTS, the temperature of battery will be set to a fixed value 25 °C.



CAUTION: Please connect the inverter to the battery rather than to the controller, if the inverter is necessary.

3 Operation

3.1 Button Function

Button	Function
SELECT button	<ul style="list-style-type: none"> • Browse interface • Setting parameter
ENTER button	<ul style="list-style-type: none"> • Load ON/OFF • Clear error • Enter into Set Mode • Save data

3.2 LCD Display

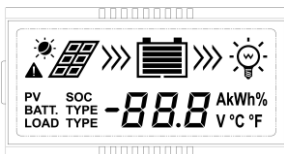

Figure 3-1 LCD

➤ Status Description

Item	Icon	Status
PV array		Day
		Night
		No charging
		Charging
	PV	PV Voltage, Current, Power
Battery		Battery capacity, In Charging
	BATT.	Battery Voltage, Current, Temperature
	BATT. TYPE	Battery Type
Load		Load ON
		Load OFF
	LOAD	Load Voltage, Current, Load mode

➤ Fault Indication

Status	Icon	Description
Battery over discharged		Battery level shows empty, battery frame blink, fault icon blink
Battery over voltage		Battery level shows full, battery frame blink, fault icon blink
Battery over temperature		Battery level shows current value, battery frame blink, fault icon blink
Load failure		Load overload ^① , Load short circuit

①When load current reaches 1.02-1.05 times, 1.05-1.25 times, 1.25-1.35 times and 1.35-1.5 times more than nominal value, controller will automatically turn off loads in 50s, 30s, 10s and 2s respectively.

➤ Browse interface

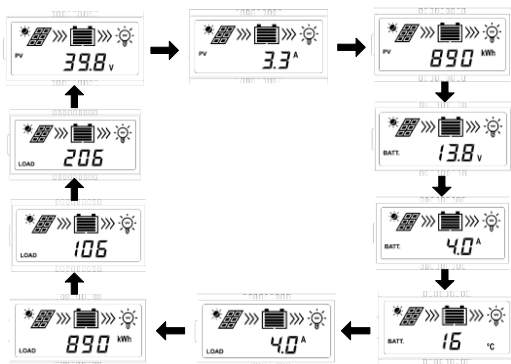

NOTE:

- 1) When no operation, the interface will be automatic cycle, but the follow two interfaces not be display.



- 2) Accumulative power zero clearing: Under PV power interface, press ENTER button and hold on 5s then the value blink, press ENTER button again to clear the value.
- 3) Setting temperature unit: Under battery temperature interface, press ENTER button and hold on 5s to switch.

3.3 Parameters setting

➤ Load mode setting

Set Load modes under below interface.



Operating Steps:

Under load mode setting interface, press ENTER button and hold on 5s till the number begin flashing, then press SELECT button to set the parameter, press ENTER button to confirm.

{**	Time 1	2**	Time 2
100	Light ON/OFF	2 7	Disabled
101	Load will be on for 1 hour since sunset	201	Load will be on for 1 hour before sunrise
102	Load will be on for 2 hours since sunset	202	Load will be on for 2 hours before sunrise
103~113	Load will be on for 3~13 hours since sunset	203~213	Load will be on for 3~13 hours before sunrise
114	Load will be on for 14 hours since sunset	214	Load will be on for 14 hours before sunrise
115	Load will be on for 15 hours since sunset	215	Load will be on for 15 hours before sunrise
116	Test mode	2 7	Disabled
117	Manual mode(Default load ON)	2 7	Disabled

NOTE: Please set Light ON/OFF, Test mode and Manual mode via Timer1. Timer2 will be disabled and display "2 7".

➤ Parameters setting

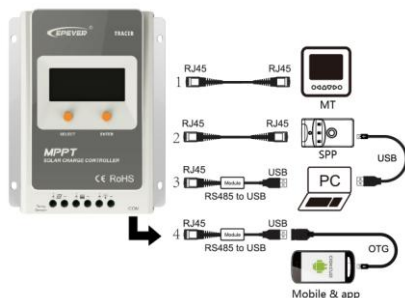
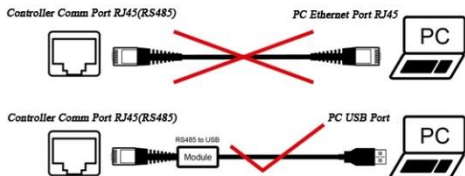

Figure 3-2 Setting operation

Four methods to configure the controller:

- 1) Remote meter, MT50 (Use standard twisted net cable, model: CC-RS485-RS485-200U-MT).
- 2) Super parameter programmer, SPP-02(Use standard twisted net cable, model: CC-RS485-RS485-200U). One-button easily configure and apply to batch setting.
- 3) PC monitoring setting software “Solar Station Monitor” (Use USB to RS485 converter cable: CC-USB-RS485-150U) .



WARNING: DO NOT communicate with the PC using the Ethernet cable, otherwise the components of controller will be damaged.

➤ The RJ45 interface pin define is shown below:

Pins	Define
1	Power supply output +5V
2	Power supply output +5V
3	RS-485-B
4	RS-485-B
5	RS-485-A
6	RS-485-A
7	Ground
8	Ground

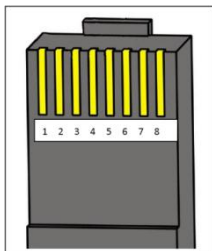

WARNING: The RJ45 interface is only allowed to connect with our company products or operated by qualified engineer. (The RJ45 interface Voltage is 5V and the current is 50mA)

- 4) Mobile APP (Use USB to RS485 converter cable: CC-USB-RS485-150U and OTG cable: OTG-12CM)

3.4 Battery Type

➤ Operating Steps

Under Battery Voltage interface, long press ENTER button enter into the interface of Battery type setting. After choosing the battery type by pressing SELECT button, waiting for 5 seconds or pressing ENTER button again to modify successfully.

➤ Battery Type



① Sealed (Default)

② Gel

③ Flooded

④ User (Apply to "MT50" and "PC software "Solar Station Monitor")

Battery Voltage Parameters (parameters is in 12V system at 25℃, please use double value in 24V.)

Battery charging setting	Sealed	Gel	Flooded	User
Over Voltage Disconnect Voltage	16.0V	16.0V	16.0V	9~17V
Charging Limit Voltage	15.0V	15.0V	15.0V	9~17V
Over Voltage Reconnect Voltage	15.0V	15.0V	15.0V	9~17V
Equalize Charging Voltage	14.6V	—	14.8V	9~17V
Boost Charging Voltage	14.4V	14.2V	14.6V	9~17V
Float Charging Voltage	13.8V	13.8V	13.8V	9~17V
Boost Reconnect Charging Voltage	13.2V	13.2V	13.2V	9~17V
Low Voltage Reconnect Voltage	12.6V	12.6V	12.6V	9~17V
Under Voltage Warning Reconnect Voltage	12.2V	12.2V	12.2V	9~17V
Under Volt. Warning Volt.	12.0V	12.0V	12.0V	9~17V
Low Volt. Disconnect Volt.	11.1V	11.1V	11.1V	9~17V
Discharging Limit Voltage	10.6V	10.6V	10.6V	9~17V
Equalize Duration (min.)	120	—	120	0~180
Boost Duration (min.)	120	120	120	10~180

NOTE:

1) When the battery type is sealed, gel, flooded, the adjusting range of equalize duration is 0 to 180min and boost duration is 10 to 180min.

2) The following rules must be observed when modifying the parameters value in user battery type (factory default value is the same as sealed type):

- a. Over Voltage Disconnect Voltage > Charging Limit Voltage \geq Equalize Charging Voltage \geq Boost Charging Voltage \geq Float Charging Voltage > Boost Reconnect Charging Voltage.
- b. Over Voltage Disconnect Voltage > Over Voltage Reconnect Voltage
- c. Low Voltage Reconnect Voltage > Low Voltage Disconnect Voltage \geq Discharging Limit Voltage.
- d. Under Voltage Warning Reconnect Voltage > Under Voltage Warning Voltage \geq Discharging Limit Voltage.
- e. Boost Reconnect Charging voltage > Low Voltage Disconnect Voltage.



CAUTION: Please refer to user guide or contact with the sales for the detail of setting operation.

4 Protections, Troubleshooting and Maintenance

4.1 Protection

- PV Over Current

The controller will limit charge power in rated charge power. An over-sized PV array will not operate at maximum power point.

- PV Short Circuit

When PV short circuit occurs, the controller will stop charging. Clear it to resume normal operation.

- PV Reverse Polarity

Fully protection against PV reverse polarity, no damage to the controller will result. Correct the miswire to resume normal operation.



WARNING: Controller will be damaged when the PV array reverse polarity and the actual operation power of the PV array is 1.5 times greater than the rated charge power!

- Battery Reverse Polarity

Fully protection against battery reverse polarity, no damage to the controller will result. Correct the miswire to resume normal operation.

- Battery Over voltage

When battery voltage reach to the voltage set point of Over Voltage Disconnect, the controller will stop charging the battery to protect the battery overcharge to break down.

- Battery Over discharge

When battery voltage reach to the voltage set point of Low Voltage Disconnect, the controller will stop discharging the battery to protect the battery over discharged to break down.

- Battery Overheating

The controller detect the battery temperature through the external temperature sensor. If the battery temperature exceeds 65°C, the controller will automatically start the overheating protection to stop working and recover below 55 °C.

- Load Overload

If the load current exceeds the maximum load current rating 1.05 times, the controller will disconnect the load. Overloading must be cleared up through reducing the load and restarting controller.

- Load Short Circuit

Fully protected against load wiring short-circuit. Once the load shorts (more than quadruple rate current), the load short protection will start automatically. After five automatic load reconnect attempts, the fault must be cleared by restarting controller.

- Damaged Remote Temperature Sensor

If the temperature sensor is short-circuited or damaged, the controller will be charging or discharging at the default temperature 25°C to prevent the battery damaged from overcharging or over discharged.









- Controller Overheating

If the temperature of the controller heat sinks exceeds 85°C, the controller will automatically start the overheating protection and recover below 75°C.

- High Voltage Transients

PV is protected against small high voltage surge. In lightning prone areas, additional external suppression is recommended.

4.2 Troubleshooting

Faults	Possible reasons	Troubleshooting
The LCD is off during daytime when sunshine falls on PV modules properly	PV array disconnection	Confirm that PV and battery wire connections are correct and tight
Wire connection is correct, LCD not display	Battery voltage is lower than 9V	Please check the voltage of battery. At least 9V voltage to activate the controller
  Interface blink	Battery voltage higher than over voltage disconnect voltage(OVD)	Check if the battery voltage is too high, and disconnect the solar module
  Interface blink	Battery under voltage	Load output is normal, charging LED indicator will return to green automatically when fully charged
  Interface blink	Battery low voltage disconnect	The controller will cut off the output automatically, LED indicator will return to green automatically when fully charged
  Interface blink	Over load or Short circuit	Remove or reduce the load and press the button, the controller will resume to work after 3 seconds

4.3 Maintenance

The following inspections and maintenance tasks are recommended at least two times per year for best performance.

- Make sure controller firmly installed in a clean and dry ambient.

- Make sure no block on air-flow around the controller. Clear up any dirt and fragments on radiator.
- Check all the naked wires to make sure insulation is not damaged for serious solarization, frictional wear, dryness, insects or rats etc. Repair or replace some wires if necessary.
- Tighten all the terminals. Inspect for loose, broken, or burnt wire connections.
- Check and confirm that LCD is consistent with required. Pay attention to any troubleshooting or error indication .Take corrective action if necessary.
- Confirm that all the system components are ground connected tightly and correctly.
- Confirm that all the terminals have no corrosion, insulation damaged, high temperature or burnt/discolored sign, tighten terminal screws to the suggested torque.
- Check for dirt, nesting insects and corrosion. If so, clear up in time.
- Check and confirm that lightning arrester is in good condition. Replace a new one in time to avoid damaging of the controller and even other equipments.



WARNING: Risk of electric shock!

Make sure that all the power is turned off before above operations, and then follow the corresponding inspections and operations.

5 Technical Specifications

Electrical Parameters

Item	Tracer 1206A	Tracer 1210A	Tracer 2210A	Tracer 3210A	Tracer 4210A
Nominal system voltage	12/24VDC Auto				
Rated charge current	10A	10A	20A	30A	40A
Rated discharge current	10A	10A	20A	30A	40A
Battery input voltage range	8V~32V				
Max. PV open circuit voltage	60V(Tracer1206A) 100V(Tracer**10A) at minimum operating environment temperature				
	46V(Tracer1206A) 92V(Tracer**10A) at 25°C environment temperature				
MPP Voltage range	$V_{BAT}+2V\sim 36V$ (Tracer1206A) $V_{BAT}+2V\sim 72V$ (Tracer**10A)				
Max. PV input power	130W/12V 260W/24V	130W/12V 260W/24V	260W/12V 520W/24V	390W/12V 780W/24V	520W/12V 1040W/24V
Self-consumption	$\leq 20mA(12V)$; $\leq 16mA(24V)$				
Discharge circuit voltage drop	$\leq 0.18V$				
Temperature compensate coefficient	$-3mV/^{\circ}C/2V$ (Default)				
Communication	RS485(RJ45 interface)				
Grounding	Common positive				

Environmental Parameters

Environmental	Parameter
LCD temperature range	$-20^{\circ}C\sim +70^{\circ}C$
Working environment temperature range*	$-25^{\circ}C\sim +45^{\circ}C$
Storage temperature range	$-35^{\circ}C\sim +80^{\circ}C$
Humidity range	$\leq 95\%$ (N.C.)
Enclosure	IP30

* Please operate controller at permitted ambient temperature. If over permissible range, please derate capacity in service.

Mechanical Parameters

Mechanical	Tracer1206A Tracer1210A	Tracer2210A
Dimension	172mmx139mmx44mm	220mm x154mm x 52mm
Mounting dimension	130mmx130mm	170mmx145mm
Mounting hole size	Φ5	
Power Terminals	12AWG(4mm ²)	6AWG(16mm ²)
Weight	0.6kg	1.1kg

Mechanical Parameters

Mechanical	Tracer3210A	Tracer4210A
Dimension	228mmx164mmx55mm	252mmx180mmx63mm
Mounting dimension	170mmx164mm	210mmx171mm
Mounting hole size	Φ5	
Power Terminals	6AWG(16mm ²)	6AWG(16mm ²)
Weight	1.2kg	1.9kg

Annex I Conversion Efficiency Curves

Illumination Intensity: 1000W/m^2 Temp: 25°C

Model: Tracer1206A

1. Solar Module MPP Voltage(17V, 34V) / Nominal System Voltage(12V)

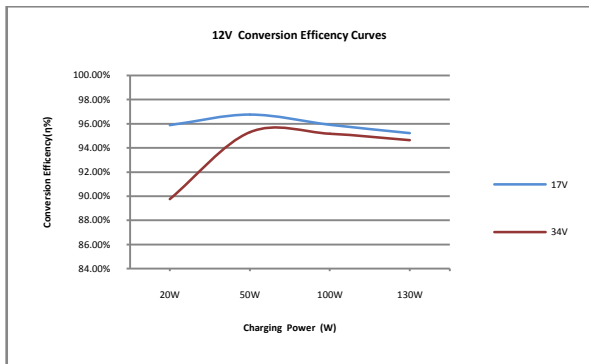

2. Solar Module MPP Voltage(34V) / Nominal System Voltage(24V)

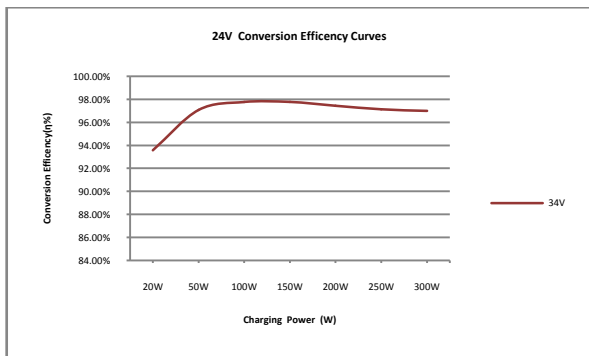

Model: Tracer1210A

Solar Module MPP Voltage(17V, 34V, 68V) / Nominal System Voltage(12V)

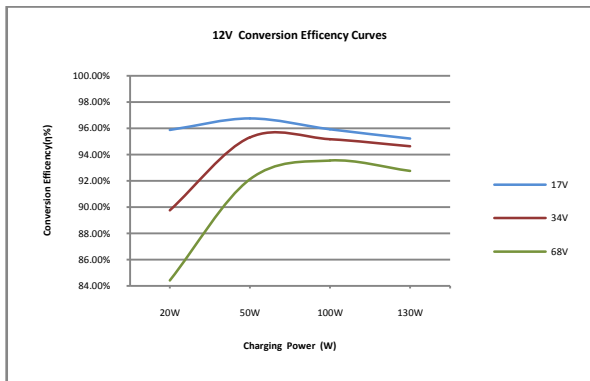

1. Solar Module MPP Voltage(34V, 68V) / Nominal System Voltage(24V)

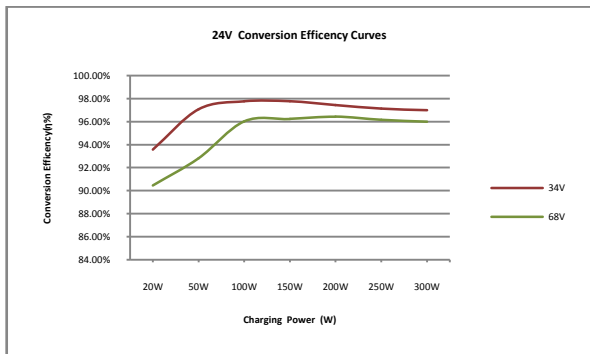

Model: Tracer2210A

Solar Module MPP Voltage(17V, 34V, 68V) / Nominal System Voltage(12V)

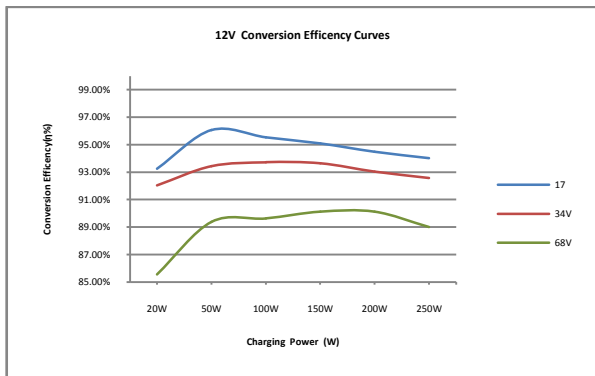

1. Solar Module MPP Voltage(33V, 68) / Nominal System Voltage(24V)

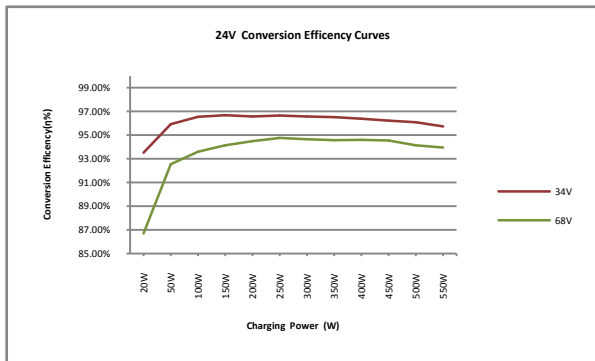

Model: Tracer3210A

Solar Module MPP Voltage(17V, 34V, 68V)/ Nominal System Voltage(12V)

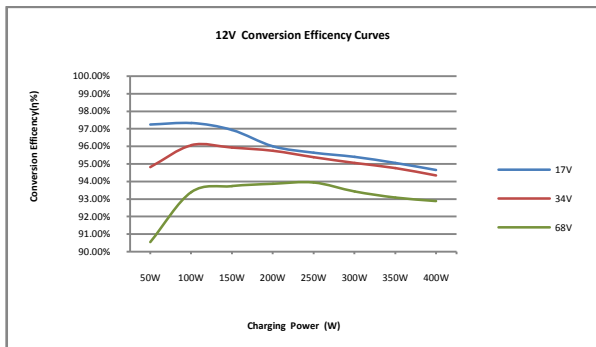

1. Solar Module MPP Voltage(34V, 68V) / Nominal System Voltage(24V)

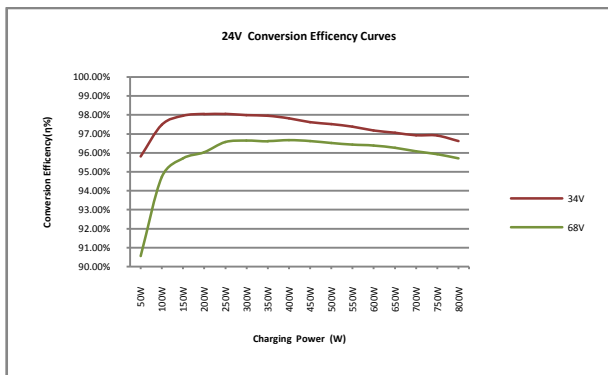

Model: Tracer4210A

1. Solar Module MPP Voltage(17V, 34V, 68V) / Nominal System Voltage(12V)

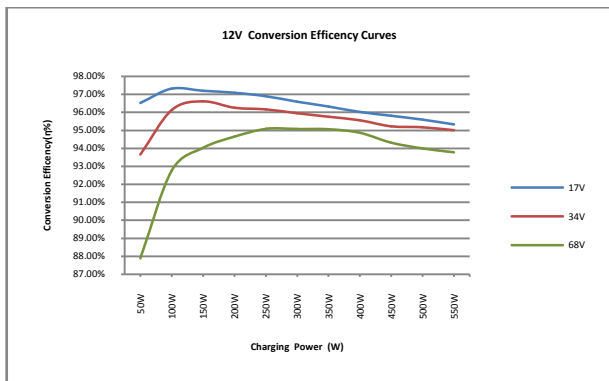

2. Solar Module MPP Voltage(34V, 68V) Nominal System Voltage(24V)

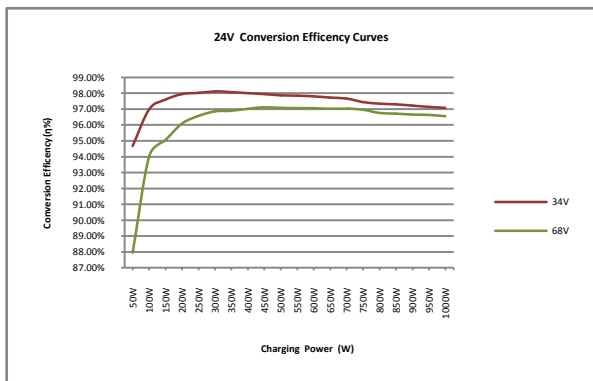

Annex II Dimensions

Tracer1206A/Tracer1210A Dimensions in Millimeters

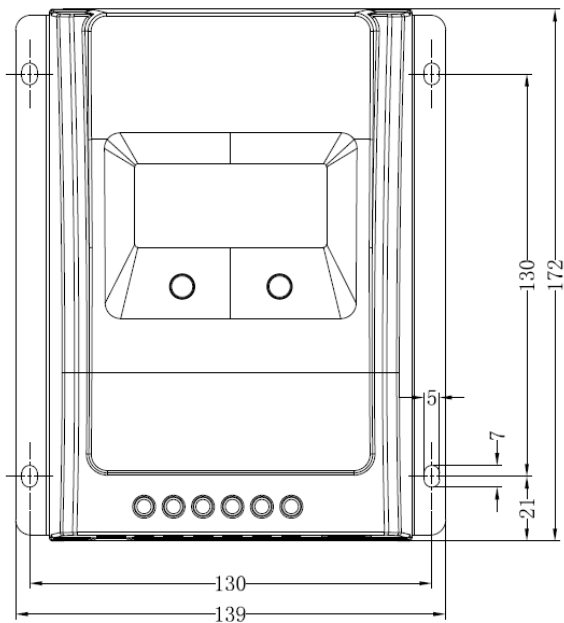
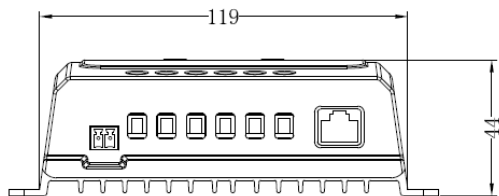

Tracer2210A Dimensions in Millimeters

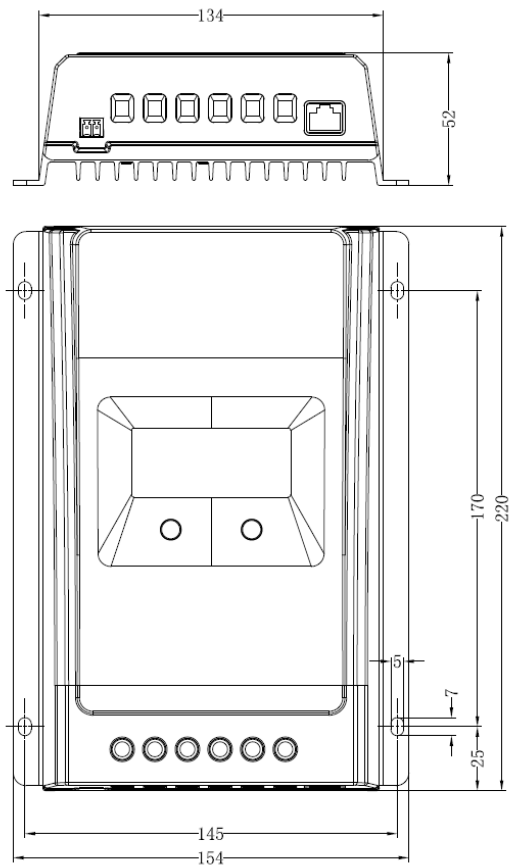

Tracer3210A Dimensions in Millimeters

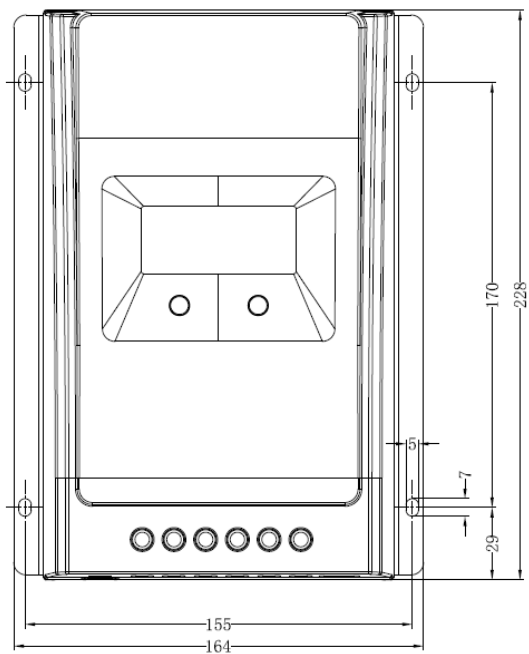
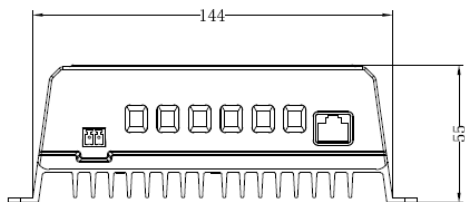

Tracer4210A Dimensions in Millimeters

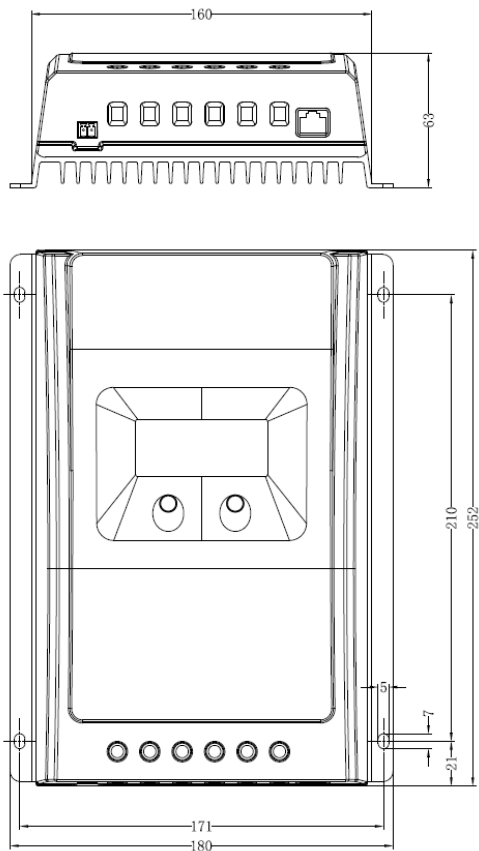

Final interpretation right of the manual belongs to EPsolar. Any changes without prior notice!

Version number: V1.4



BEIJING EPSOLAR TECHNOLOGY CO., LTD.

Tel: +86-10-82894112 / 82894962

Fax: +86-10-82894882

E-mail: info@epsolarpv.com

Website: <http://www.epsolarpv.com/>

<http://www.epever.com/>